

Flexible

# KURV-X Fixture Guide

# KKDÖ

Indoor/Outdoor | Recessed | Output up to 550lm/m (167lm/ft)



## Key applications

- ✓ Architectural detail
- ✓ Bathrooms
- ✓ Building façades
- ✓ Cabinet/Furniture
- ✓ Interior/Exterior
- ✓ Mirror back lighting
- ✓ Under cabinet
- ✓ Wet area
- ✓ Window Reveal

## Key features

- ✓ Custom lengths
- ✓ Diffusion: Homogenous
- ✓ Direct view
- ✓ IP67
- ✓ Thin light line
- ✓ Trimless

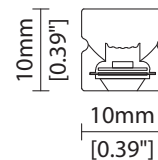

## MOUNTING METHODS



KKCP-19 Mounting clip

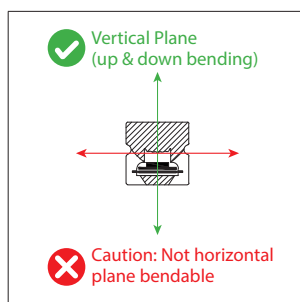

Flexible

# KURV-X

## Specification sheet



<b>Dimensions</b>	H12.4/W12.4/L41.7-5000mm (H0.49/W0.49/L1.64-196.9in) + end cap length
<b>PCB Cut-point</b>	41.67mm increment/5000mm max (1.64in increment/196.9in max)
<b>LED Pitch</b>	6.95mm - 144LED/m (0.27in - 44LED/ft)
<b>Chip</b>	<b>s-line</b> <b>k-line</b>
<b>Cover/Optics</b>	Diffused (130°)
<b>CCT</b>	<b>s-line:</b> 2400K/2700K/3000K/3500K/4300K <b>k-line:</b> 2400K/2700K/3000K/3500K/4300K
<b>LED binning</b>	<b>s-line:</b> 2-step MacAdam ellipse <b>k-line:</b> 3-step MacAdam ellipse
<b>CRI</b>	≥ 90
<b>Lifetime</b>	50,000 hours @ 25°C (50,000 hours @ 77°F)
<b>Operating temp</b>	T <sub>a</sub> = -25 to 40°C (T <sub>c</sub> max = 65°C) T <sub>a</sub> = -13 to 104°F (T <sub>c</sub> max = 149°F)
<b>IP Rating</b>	IP67
<b>Finish</b>	White Silicone
<b>Mounting</b>	Surface Mounting via concealed clip
<b>Min bend radius</b>	125mm (4.92in)
<b>Power feed</b>	Sheathed hardwire tails or male/female connectors
<b>Control</b>	0-10V/1-10V/DMX/DALI

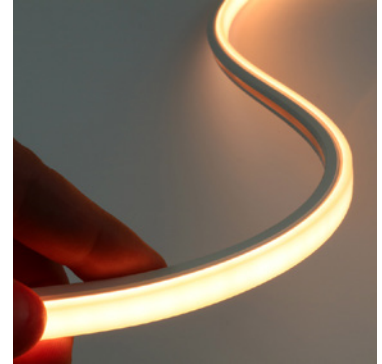

### LED Grading Key

#### Exclusive Grade

<b>s</b> s-line*	*KKDC tuned CCT range
2-step CCT range	

#### Base Grade

<b>k</b> k-line	3-step commercial range
Energy Star CCTs	

<b>Power consumption</b>	<b>Supply voltage</b>	<b>Supply current</b>
12W/m (3.66W/ft)	24V DC	0.5A/m (0.15A/ft)

### Performance Data (3000K)

	R1	R2	R3	R4	R5	R6	R7	R8	R9	R10	R11	R12	R13	R14
<b>s-line</b>	90	94	97	90	90	93	91	79	56	86	90	78	91	97
<b>k-line</b>	90	94	97	90	90	93	91	79	56	86	90	78	91	97

### Diffused Cover

													<b>CRI</b>	<b>R9</b>	<b>Rf</b>	<b>Rg</b>
<b>s-line</b>	550lm/m (167lm/ft)												90	56	-	-
<b>k-line</b>	480lm/m (146lm/ft)												90	56	-	-
	45.8lm/W															
	40lm/W															

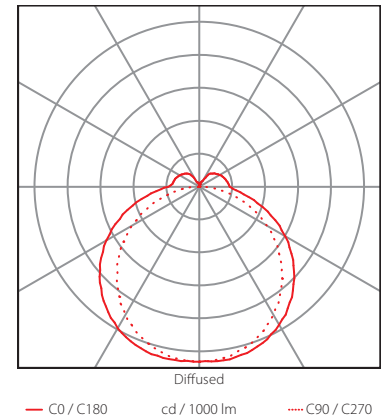
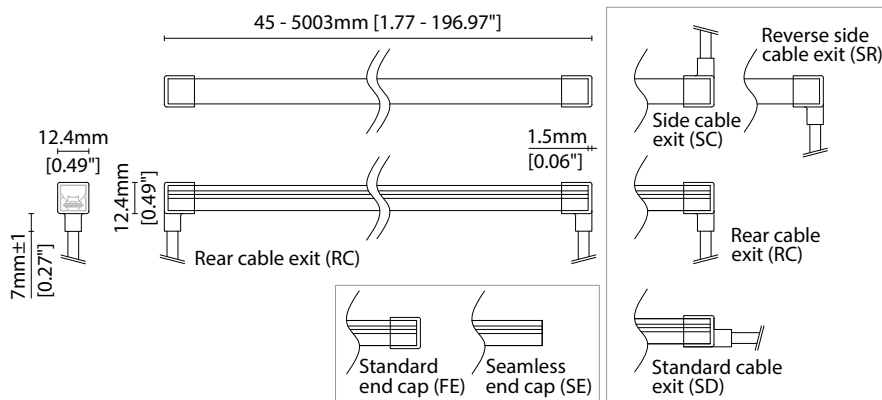

Data derived from independent UKAS / IESNA LM-79-08 accredited testing of production samples.



# KURV-X Code Table



## FIXTURE

Model	Cover	Grade <sup>1</sup>	LED	Colour (CCT)	Length Availability <sup>2</sup>	IP	Cable Length	Power Feed <sup>3</sup>	Cable Exit	End Cap <sup>4</sup>	Input													
KURV-X	KK	Diffused	c	s	s	960	2400	24	m	45-5003mm 41.67mm increments	IP67	67	300mm (11.81")	0300	Single ø4.3mm sheath tail	S00A	Rear Cable Exit	RC	End cap	FE	DC 24V	g		
							2700	27							Double ø4.3mm sheath tail	D00A	Side Cable Exit	SC	Seamless end cap	SE				
							3000	30															i	1.77-196.97in 1.64in increments
							3500	35																
4300	43	(Specify length code OR total run length)		Single ø4.3mm sheath IP67 connector	S67A	End Cable Exit	SD																	
															Double ø4.3mm sheath IP67 connector	D67A	Reverse Side cable Exit	SR						

<sup>1</sup> Refer to **LED Grading Key** on **Specification sheet** page

<sup>2</sup> Refer to **Length Availability List** or enter total run length instead of length code

<sup>3</sup> Refer to **Power Feed Options** on **Options** pages

<sup>4</sup> Refer to **End Cap Options** on **Options** pages

## Code Example:

KK	-	c	-	s	-	960	-	30	-	m	-	500	-	67	-	0300	-	D67A	-	RC	-	FE	-	g
KURV-X		Diffused				960		3000K		500mm		IP67		300mm (11.81")		Double ø4.3mm sheath IP67 connector		Rear Cable Exit		End cap		DC 24V		

## ACCESSORIES

### Mounting Accessories

KKCP-19 Clip

\* Refer to **Mounting Accessories** on **Accessories** pages

### End cap Accessories

KXEC-01 End cap

KXEC-02 Seamless end cap

\* Refer to **End Cap Accessories** on **Accessories** pages

### Connection Accessories

CN67-2P-0300 IP67 2 PIN male & female 300mm/11.81" pair

CN67-2P-1000 IP67 2 PIN male & female 1000mm/39.37" pair

CN67-2P-3000 IP67 2 PIN male & female 3000mm/118.11" pair

\* Refer to **Power feed** on **Accessories** pages

### PSU/Driver

0-10V/1-10V/DALI/DMX

\* Refer to **Driver/PSU Options** page for details or provide requirement and KKDC to offer the suitable option

Flexible

# KURV-X

## Length Availability List



Length Code		Fixture Length <sup>1</sup>		LED Strip <sup>2</sup>		End Cap Dimension		Wattage (W)	Output (lm)
Metric	Imperial(US)	Metric	Imperial(US)	Metric	Imperial(US)	Metric	Imperial(US)		3000K (Test Data)
m0045	i0002	45mm	1.76in	42mm	1.64in	3mm	0.12in	0.50	20
m0086	i0003	86mm	3.40in	83mm	3.28in	3mm	0.12in	1.00	40
m0128	i0005	128mm	5.04in	125mm	4.92in	3mm	0.12in	1.50	60
m0170	i0007	170mm	6.68in	167mm	6.56in	3mm	0.12in	2.00	80
m0211	i0008	211mm	8.32in	208mm	8.20in	3mm	0.12in	2.50	100
m0253	i0010	253mm	9.96in	250mm	9.84in	3mm	0.12in	3.00	120
m0295	i0012	295mm	11.60in	292mm	11.48in	3mm	0.12in	3.50	140
m0336	i0013	336mm	13.24in	333mm	13.12in	3mm	0.12in	4.00	160
m0378	i0015	378mm	14.88in	375mm	14.76in	3mm	0.12in	4.50	180
m0420	i0017	420mm	16.52in	417mm	16.41in	3mm	0.12in	5.00	200
m0461	i0018	461mm	18.16in	458mm	18.05in	3mm	0.12in	5.50	220
m0503	i0020	503mm	19.80in	500mm	19.69in	3mm	0.12in	6.00	240
m0545	i0021	545mm	21.45in	542mm	21.33in	3mm	0.12in	6.50	260
m0586	i0023	586mm	23.09in	583mm	22.97in	3mm	0.12in	7.00	280
m0628	i0025	628mm	24.73in	625mm	24.61in	3mm	0.12in	7.50	300
m0670	i0026	670mm	26.37in	667mm	26.25in	3mm	0.12in	8.00	320
m0711	i0028	711mm	28.01in	708mm	27.89in	3mm	0.12in	8.50	340
m0753	i0030	753mm	29.65in	750mm	29.53in	3mm	0.12in	9.00	360
m0795	i0031	795mm	31.29in	792mm	31.17in	3mm	0.12in	9.50	380
m0836	i0033	836mm	32.93in	833mm	32.81in	3mm	0.12in	10.00	400
m0878	i0035	878mm	34.57in	875mm	34.45in	3mm	0.12in	10.50	420
m0920	i0036	920mm	36.21in	917mm	36.09in	3mm	0.12in	11.00	440
m0961	i0038	961mm	37.85in	958mm	37.73in	3mm	0.12in	11.50	460
m1003	i0039	1003mm	39.49in	1000mm	39.37in	3mm	0.12in	12.00	480
m1045	i0041	1045mm	41.13in	1042mm	41.01in	3mm	0.12in	12.50	500
m1086	i0043	1086mm	42.77in	1083mm	42.65in	3mm	0.12in	13.00	520
m1128	i0044	1128mm	44.41in	1125mm	44.29in	3mm	0.12in	13.50	540
m1170	i0046	1170mm	46.05in	1167mm	45.94in	3mm	0.12in	14.00	560
m1211	i0048	1211mm	47.69in	1208mm	47.58in	3mm	0.12in	14.50	580
m1253	i0049	1253mm	49.33in	1250mm	49.22in	3mm	0.12in	15.00	600
m1295	i0051	1295mm	50.98in	1292mm	50.86in	3mm	0.12in	15.50	620
m1336	i0053	1336mm	52.62in	1333mm	52.50in	3mm	0.12in	16.00	640
m1378	i0054	1378mm	54.26in	1375mm	54.14in	3mm	0.12in	16.50	660
m1420	i0056	1420mm	55.90in	1417mm	55.78in	3mm	0.12in	17.00	680
m1461	i0058	1461mm	57.54in	1458mm	57.42in	3mm	0.12in	17.50	700
m1503	i0059	1503mm	59.18in	1500mm	59.06in	3mm	0.12in	18.00	720
m1545	i0061	1545mm	60.82in	1542mm	60.70in	3mm	0.12in	18.50	740
m1586	i0062	1586mm	62.46in	1583mm	62.34in	3mm	0.12in	19.00	760
m1628	i0064	1628mm	64.10in	1625mm	63.98in	3mm	0.12in	19.50	780

Flexible

# KURV-X

## Length Availability List



Length Code		Fixture Length <sup>1</sup>		LED Strip <sup>2</sup>		End Cap Dimension		Wattage (W)	Output (lm)
Metric	Imperial(US)	Metric	Imperial(US)	Metric	Imperial(US)	Metric	Imperial(US)		3000K (Test Data)
m1670	i0066	1670mm	65.74in	1667mm	65.62in	3mm	0.12in	20.00	800
m1711	i0067	1711mm	67.38in	1708mm	67.26in	3mm	0.12in	20.50	820
m1753	i0069	1753mm	69.02in	1750mm	68.90in	3mm	0.12in	21.00	840
m1795	i0071	1795mm	70.66in	1792mm	70.54in	3mm	0.12in	21.50	860
m1836	i0072	1836mm	72.30in	1833mm	72.18in	3mm	0.12in	22.00	880
m1878	i0074	1878mm	73.94in	1875mm	73.82in	3mm	0.12in	22.50	900
m1920	i0076	1920mm	75.58in	1917mm	75.47in	3mm	0.12in	23.00	920
m1961	i0077	1961mm	77.22in	1958mm	77.11in	3mm	0.12in	23.50	940
m2003	i0079	2003mm	78.86in	2000mm	78.75in	3mm	0.12in	24.00	960
m2045	i0081	2045mm	80.51in	2042mm	80.39in	3mm	0.12in	24.50	980
m2087	i0082	2087mm	82.15in	2084mm	82.03in	3mm	0.12in	25.00	1000
m2128	i0084	2128mm	83.79in	2125mm	83.67in	3mm	0.12in	25.50	1020
m2170	i0085	2170mm	85.43in	2167mm	85.31in	3mm	0.12in	26.00	1040
m2212	i0087	2212mm	87.07in	2209mm	86.95in	3mm	0.12in	26.50	1060
m2253	i0089	2253mm	88.71in	2250mm	88.59in	3mm	0.12in	27.00	1080
m2295	i0090	2295mm	90.35in	2292mm	90.23in	3mm	0.12in	27.50	1100
m2337	i0092	2337mm	91.99in	2334mm	91.87in	3mm	0.12in	28.00	1120
m2378	i0094	2378mm	93.63in	2375mm	93.51in	3mm	0.12in	28.50	1140
m2420	i0095	2420mm	95.27in	2417mm	95.15in	3mm	0.12in	29.00	1160
m2462	i0097	2462mm	96.91in	2459mm	96.79in	3mm	0.12in	29.50	1180
m2503	i0099	2503mm	98.55in	2500mm	98.43in	3mm	0.12in	30.00	1200
m2545	i0100	2545mm	100.19in	2542mm	100.07in	3mm	0.12in	30.50	1220
m2587	i0102	2587mm	101.83in	2584mm	101.71in	3mm	0.12in	31.00	1240
m2628	i0103	2628mm	103.47in	2625mm	103.35in	3mm	0.12in	31.50	1260
m2670	i0105	2670mm	105.11in	2667mm	105.00in	3mm	0.12in	32.00	1280
m2712	i0107	2712mm	106.75in	2709mm	106.64in	3mm	0.12in	32.50	1300
m2753	i0108	2753mm	108.39in	2750mm	108.28in	3mm	0.12in	33.00	1320
m2795	i0110	2795mm	110.04in	2792mm	109.92in	3mm	0.12in	33.50	1340
m2837	i0112	2837mm	111.68in	2834mm	111.56in	3mm	0.12in	34.00	1360
m2878	i0113	2878mm	113.32in	2875mm	113.20in	3mm	0.12in	34.50	1380
m2920	i0115	2920mm	114.96in	2917mm	114.84in	3mm	0.12in	35.00	1400
m2962	i0117	2962mm	116.60in	2959mm	116.48in	3mm	0.12in	35.50	1420
m3003	i0118	3003mm	118.24in	3000mm	118.12in	3mm	0.12in	36.00	1440
m3045	i0120	3045mm	119.88in	3042mm	119.76in	3mm	0.12in	36.50	1460
m3087	i0122	3087mm	121.52in	3084mm	121.40in	3mm	0.12in	37.00	1480
m3128	i0123	3128mm	123.16in	3125mm	123.04in	3mm	0.12in	37.50	1500
m3170	i0125	3170mm	124.80in	3167mm	124.68in	3mm	0.12in	38.00	1520
m3212	i0126	3212mm	126.44in	3209mm	126.32in	3mm	0.12in	38.50	1540
m3253	i0128	3253mm	128.08in	3250mm	127.96in	3mm	0.12in	39.00	1560

Flexible

# KURV-X

## Length Availability List



Length Code		Fixture Length <sup>1</sup>		LED Strip <sup>2</sup>		End Cap Dimension		Wattage (W)	Output (lm)
Metric	Imperial(US)	Metric	Imperial(US)	Metric	Imperial(US)	Metric	Imperial(US)		3000K (Test Data)
m3295	i0130	3295mm	129.72in	3292mm	129.60in	3mm	0.12in	39.50	1580
m3337	i0131	3337mm	131.36in	3334mm	131.24in	3mm	0.12in	40.00	1600
m3378	i0133	3378mm	133.00in	3375mm	132.88in	3mm	0.12in	40.50	1620
m3420	i0135	3420mm	134.64in	3417mm	134.53in	3mm	0.12in	41.00	1640
m3462	i0136	3462mm	136.28in	3459mm	136.17in	3mm	0.12in	41.50	1660
m3503	i0138	3503mm	137.92in	3500mm	137.81in	3mm	0.12in	42.00	1680
m3545	i0140	3545mm	139.56in	3542mm	139.45in	3mm	0.12in	42.50	1700
m3587	i0141	3587mm	141.21in	3584mm	141.09in	3mm	0.12in	43.00	1720
m3628	i0143	3628mm	142.85in	3625mm	142.73in	3mm	0.12in	43.50	1740
m3670	i0144	3670mm	144.49in	3667mm	144.37in	3mm	0.12in	44.00	1760
m3712	i0146	3712mm	146.13in	3709mm	146.01in	3mm	0.12in	44.50	1780
m3753	i0148	3753mm	147.77in	3750mm	147.65in	3mm	0.12in	45.00	1800
m3795	i0149	3795mm	149.41in	3792mm	149.29in	3mm	0.12in	45.50	1820
m3837	i0151	3837mm	151.05in	3834mm	150.93in	3mm	0.12in	46.00	1840
m3878	i0153	3878mm	152.69in	3875mm	152.57in	3mm	0.12in	46.50	1860
m3920	i0154	3920mm	154.33in	3917mm	154.21in	3mm	0.12in	47.00	1880
m3962	i0156	3962mm	155.97in	3959mm	155.85in	3mm	0.12in	47.50	1900
m4003	i0158	4003mm	157.61in	4000mm	157.49in	3mm	0.12in	48.00	1920
m4045	i0159	4045mm	159.25in	4042mm	159.13in	3mm	0.12in	48.50	1940
m4087	i0161	4087mm	160.89in	4084mm	160.77in	3mm	0.12in	49.00	1960
m4128	i0163	4128mm	162.53in	4125mm	162.41in	3mm	0.12in	49.50	1980
m4170	i0164	4170mm	164.17in	4167mm	164.06in	3mm	0.12in	50.00	2000
m4212	i0166	4212mm	165.81in	4209mm	165.70in	3mm	0.12in	50.50	2020
m4253	i0167	4253mm	167.45in	4250mm	167.34in	3mm	0.12in	51.00	2040
m4295	i0169	4295mm	169.09in	4292mm	168.98in	3mm	0.12in	51.50	2060
m4337	i0171	4337mm	170.74in	4334mm	170.62in	3mm	0.12in	52.00	2080
m4378	i0172	4378mm	172.38in	4375mm	172.26in	3mm	0.12in	52.50	2100
m4420	i0174	4420mm	174.02in	4417mm	173.90in	3mm	0.12in	53.00	2120
m4462	i0176	4462mm	175.66in	4459mm	175.54in	3mm	0.12in	53.50	2140
m4503	i0177	4503mm	177.30in	4500mm	177.18in	3mm	0.12in	54.00	2160
m4545	i0179	4545mm	178.94in	4542mm	178.82in	3mm	0.12in	54.50	2180
m4587	i0181	4587mm	180.58in	4584mm	180.46in	3mm	0.12in	55.00	2200
m4628	i0182	4628mm	182.22in	4625mm	182.10in	3mm	0.12in	55.50	2220
m4670	i0184	4670mm	183.86in	4667mm	183.74in	3mm	0.12in	56.00	2240
m4712	i0186	4712mm	185.50in	4709mm	185.38in	3mm	0.12in	56.50	2260
m4753	i0187	4753mm	187.14in	4750mm	187.02in	3mm	0.12in	57.00	2280
m4795	i0189	4795mm	188.78in	4792mm	188.66in	3mm	0.12in	57.50	2300
m4837	i0190	4837mm	190.42in	4834mm	190.30in	3mm	0.12in	58.00	2320
m4878	i0192	4878mm	192.06in	4875mm	191.94in	3mm	0.12in	58.50	2340

# KURV-X

## Length Availability List

Length Code		Fixture Length <sup>1</sup>		LED Strip <sup>2</sup>		End Cap Dimension		Wattage (W)	Output (lm) 3000K (Test Data)
Metric	Imperial(US)	Metric	Imperial(US)	Metric	Imperial(US)	Metric	Imperial(US)		
m4920	i0194	4920mm	193.70in	4917mm	193.59in	3mm	0.12in	59.00	2360
m4962	i0195	4962mm	195.34in	4959mm	195.23in	3mm	0.12in	59.50	2380
m5003	i0197	5003mm	196.98in	5000mm	196.87in	3mm	0.12in	60.00	2400

<sup>1</sup> Actual total overall length of light fixture (LED strip + end caps + void/wire hole)

<sup>2</sup> Actual length of PCB strip

<sup>3</sup> Actual Length varies by 'end cap' option

Side / Rear cable exit (SC / RC / SR)

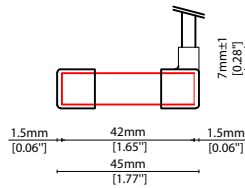

End cable exit (SD)

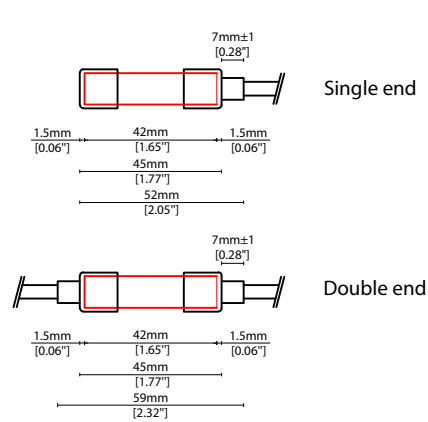

**Note:**  
For seamless end cap  
3mm would be reduced  
from Fixture length.

### POWER FEED OPTIONS

\* Options are an integral part of the fixture ordering codes. Please refer to **Code Table** pages.

#### 0300 S00A 300mm (11.81") Single Ø4.3mm sheath tail

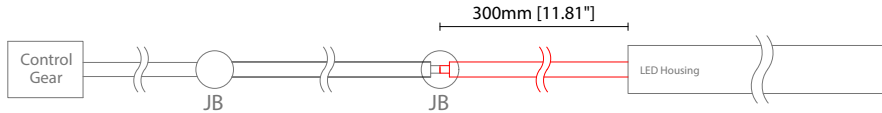

#### 0300 D00A 300mm (11.81") Double Ø4.3mm sheath tail

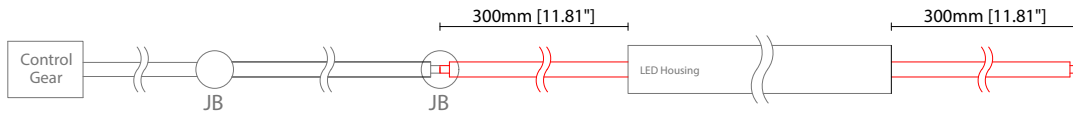

#### 0300 S67A 300mm (11.81") Single Ø4.3mm sheath connector IP67 (Premoulded)

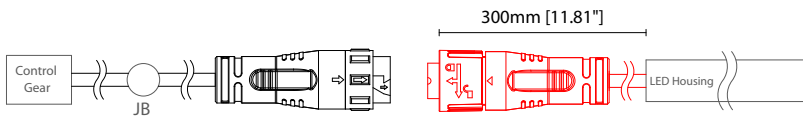

#### 0300 D67A 300mm (11.81") Double Ø4.3mm sheath connector IP67 (Premoulded)

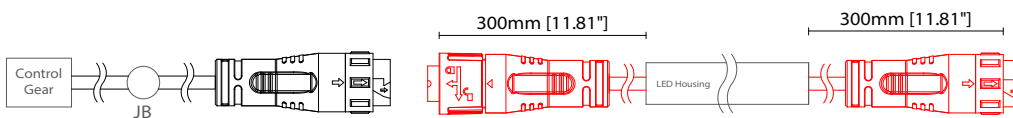

#### 2 Pin Female Connector IP67 (Premoulded)

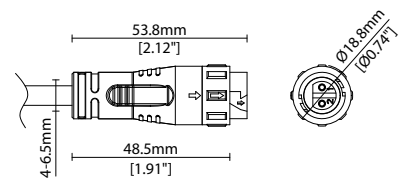

#### 2 Pin Male Connector IP67 (Premoulded)

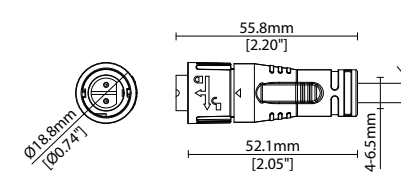

#### Key

Control Gear Power supply, sub-controllers & control systems

JB Junction box / cable connection



### CABLE EXIT OPTIONS

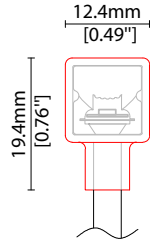
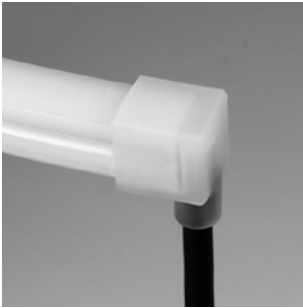

#### RC Rear cable exit

End cap with the cable exit projecting from the back of product.

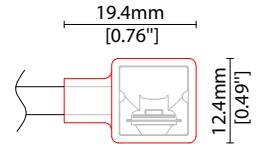
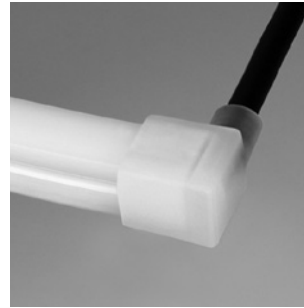

#### SC Side cable exit

End cap with the cable exit projecting from the side of product.

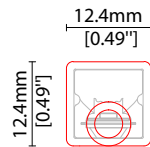
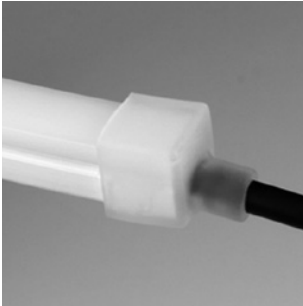

#### SD End cable exit

End cap with the cable exit projecting from end of product.

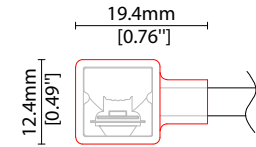

#### SR Reverse side cable exit

End cap with the cable exit projecting from the side of product.

### END CAP OPTIONS

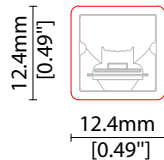

#### FE KURV-X End cap

Standard sealed end cap method suitable for surface mounting. Increases product length by 3mm

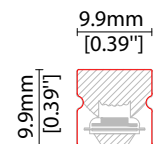
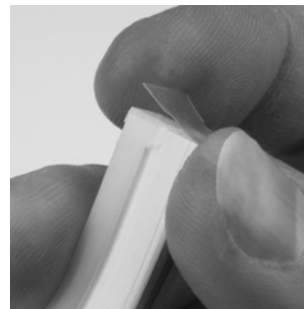

#### SE KURV-X Seamless end cap

End cap sticker required for flush recessing and homogenous end to end lighting.

W9.9/H9.9mm (W0.39/0.39").  
Increases product length by 0.2mm

Flexible

# KURV-X Accessories

# KKDÖ

## MOUNTING ACCESSORIES

Note: Accessories are to be ordered separately with corresponding code shown below.



**KKCP-19**

Mounting clip  
(allow of 3 per metre/40")  
*Note: number of clips may depend on design*

Anodised aluminium finish

L20/W12/H12.6mm  
(L0.79/W0.47/H0.50")

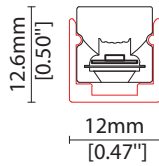

## END CAP ACCESSORIES (FOR ON-SITE CUTTING)

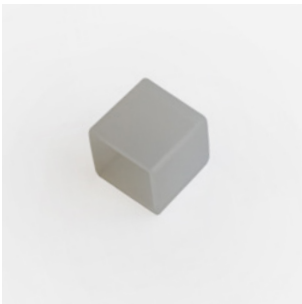

**KXEC-01**

KURV-X end cap  
Standard silicone end cap for sealing cut end, suitable when surface mounting (Refer to installation guide).  
W12.4/H12.4mm  
(W0.49/H0.49").  
Increases product length by 3mm

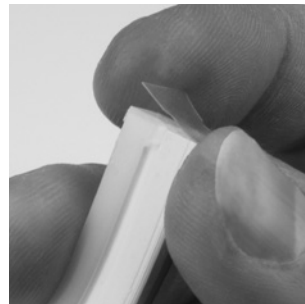
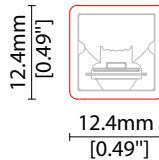

**KXEC-02**

KURV-X Seamless end cap  
Self-adhesive end cap sticker for sealing cut end. Suitable when flush recessing/for homogenous end to end lighting (Refer to installation guide).  
W9.9/H9.9mm  
(W0.39/H0.39").  
Increases product length by 0.2mm

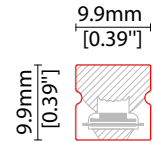

Flexible

# KURV-X Accessories

# KKDC

## POWER FEED

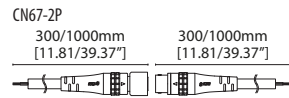

CN67-2P-0300 300mm (11.81in) pair  
CN67-2P-1000 1000mm (39.37in) pair  
IP67  
2 PIN male + female connector set



CN67-2P-3000 3000mm (118.11in) pair  
IP67  
2 PIN male + female connector set

## EXTERIOR JUNCTION BOXES



KKJB-07  
IP67 Slim J-Box  
(including type A,B,C,D bushings)



KKJB-07R  
Potting resin for IP67 Slim J-Box

## KKDC CONTROL



IP20  
Plastic housing  
L170/W59/H29mm  
(L6.69/W2.32/H1.14in)

KKDM-06 1-10V  
visDIM dimmable sub-controller  
(4 x 8A max @ 12-36V)



IP20  
Plastic housing  
L170/W53.4/H28mm  
(L6.69/W2.10/H1.10in)

KKSC-05 DMX  
visDIM dimmable sub-controller  
(4 x 5A max @ 12-36V)



# KURV-X Accessories



## KKDC CONTROL (CONTINUED)

---



IP20  
Plastic housing  
L170/W59/H29mm  
(L6.69/W2.32/H1.14in)

### KKDL-02 DALI

visDIM dimmable sub-controller  
(4 x 8A max @ 12-36V)



IP20  
Plastic housing  
L166/W53.4/H23mm  
(L6.54/W2.10/H0.91in)

### KKDL-03 DALI

visDIM dimmable sub-controller  
(4 x 5A max @ 12-36V)

### AVAILABLE PSU OPTIONS

Control Mode	PSU (Order Code)	Input Voltage AC	Output Voltage DC	Rated Output Current	Rated Power	Dim %	IP Rating
Switched	CEN-60-24	90-295V	24V	2.5A	60W	-	IP67
	HLG-60H-24	90-305V	24V	2.5A	60W	-	IP67
	HLG-100H-24	90-305V	24V	4.0A	100W	-	IP67
	HLG-150H-24	90-305V	24V	6.3A	150W	-	IP67
	HLG-240H-24	90-305V	24V	10A	240W	-	IP67
0-10V (1-10V)	PWM-40-24	90-305V	24V	1.67A	40W	100-0.15 (100-10)	IP67
	PWM-60-24	90-305V	24V	2.5A	60W	100-0.15 (100-10)	IP67
	PWM-90-24	90-305V	24V	3.67A	90W	100-0.15 (100-10)	IP67
	PWM-120-24	90-305V	24V	5.0A	120W	100-0.15 (100-10)	IP67
DALI	LIN100A1	120-277V	24V	1A per channel	100W	100-0.1	IP66/IP40
DMX RGB	LIN100A1	120-277V	24V	1.33A per channel	100W	100-0.1	IP66/IP40
DMX RGBW	LIN100A1	120-277A	24V	1A per channel	100W	100-0.1	IP66/IP40

### Flicker Free Options - Combination of PSU+ sub-controller

Control Mode	PSU (Order Code)	Sub-controller (Order Code)	Input Voltage AC	Output Voltage DC	Rated Output Current	Rated Power	Dim %	IP Rating PSU/ Sub-controller
0-10V or 1-10V	CEN-60-24	KKDM-06	90-295V	24V	2.5A	60W	100-0.9	IP67/IP20
	HLG-60H-24	KKDM-06	90-295V	24V	2.5A	60W	100-0.9	IP67/IP20
	HLG-100H-24	KKDM-06	90-295V	24V	4.0A	100W	100-0.9	IP67/IP20
	HLG-150H-24	KKDM-06	90-295V	24V	6.3A	150W	100-0.9	IP67/IP20
	HLG-240H-24	KKDM-06	90-295V	24V	10.0A	240W	100-0.9	IP67/IP20
DALI	CEN-60-24	KKDL-02/03	90-295V	24V	2.5A	60W	100-0.1	IP67/IP20
	HLG-60H-24	KKDL-02/03	90-305V	24V	2.5A	60W	100-0.1	IP67/IP20
	HLG-100H-24	KKDL-02/03	90-305V	24V	4.0A	100W	100-0.1	IP67/IP20
	HLG-150H-24	KKDL-02/03	90-305V	24V	6.3A	150W	100-0.1	IP67/IP20
	HLG-240H-24	KKDL-02/03	90-305V	24V	10.0A	240W	100-0.1	IP67/IP20
DMX RGB	CEN-60-24	KKSC-05	90-295V	24V	2.5A	60W	100-0.9	IP67/IP20
	HLG-60H-24	KKSC-05	90-305V	24V	2.5A	60W	100-0.9	IP67/IP20
	HLG-100H-24	KKSC-05	90-305V	24V	4A	100W	100-0.9	IP67/IP20
	HLG-150H-24	KKSC-05	90-305V	24V	6.3A	150W	100-0.9	IP67/IP20
	HLG-240H-24	KKSC-05	90-305V	24V	10.0A	240W	100-0.9	IP67/IP20

<sup>1</sup> The items shown above cover the most frequently used specification but does not exhaust the possible options

<sup>2</sup> PSU and/or driver can be chosen from the table, or KKDC may recommend the best option upon receipt of the controls requirement and installation environment

<sup>3</sup> Electrical shop drawing will include detailed information of PSU and relevant control drivers

<sup>4</sup> Cut sheets are available on the controls section of [www.kkdc.lighting](http://www.kkdc.lighting) or upon request