

Linear

MOMO-F A040 (40W)

Fixture Guide

KKDÖ

Indoor/Outdoor | Recessed | Output up to 3656lm/m (1114lm/ft)



Key applications

- ✓ Bathrooms
- ✓ Building facades
- ✓ Direct lighting
- ✓ Exterior
- ✓ In ground
- ✓ Interior
- ✓ Orientation lighting
- ✓ Pathways/driveways
- ✓ Uplighting
- ✓ Wall grazing
- ✓ Wallwashing
- ✓ Wet area

Key features

- ✓ A-line (High Efficacy)
- ✓ Asymmetric lens
- ✓ Custom lengths
- ✓ Constant Voltage (CV)
- ✓ Diffusion: homogenous
- ✓ Direct view
- ✓ Glare control options
- ✓ High lumen efficacy
- ✓ IP67 waterproof

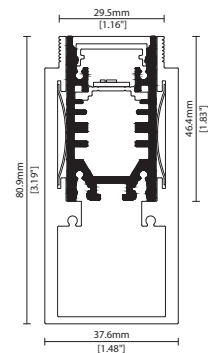

MOUNTING METHODS



KKFR-03 Ground box



KKCP-11 Concealed clip

Linear

MOMO-F A040 (40W)

Specification sheet



Dimensions	H46.4/W25/L97-1520mm* (H1.83/W0.98/L3.82-59.84in*) *KKLN-A2 = 1020mm/40.16in max
PCB Cut-point	38.46mm increment/1500mm max* (1.51in increment/59.06in max*) *KKLN-A2 = 1000mm/39.37in max
LED Pitch	4.8mm - 208LED/m (0.19in - 64LED/ft)
Chip	A-line
Cover/Optics	Clear (100°)/Clear + Micro louvre/Clear + KKLN-03 lens (23°)/ Clear + KKLN-03 lens (23°) + Micro louvre/Clear + Asymmetric lens (KKLN-A2)/Diffused (95°)
CCT	A-line: 2700K/3000K/4000K
LED binning	A-line: 3-step MacAdam ellipse
CRI	≥93
Lifetime	50,000 hours @ 25°C (50,000 hours @ 77°F)
Operating temp	T _a = -25 to 50°C (T _c max = 72.9°C) T _a = -13 to 122°F (T _c max = 163°F)
IP Rating	IP67
Finish	Silver anodised
Mounting	Ground recessed or surface mounted via concealed clips
Power feed	Sheathed hardwire tails or male/female connectors
Control	0-10V/1-10V/DMX/DALI



LED Grading Key

Exclusive Grade *KKDC tuned CCT range
A-line* 3-step CCT range
 KKDC highest lumen efficacy LED

Power consumption	Supply voltage	Supply current
40W/m (12.19W/ft)	24V DC	1.67A/m (0.51A/ft)

Performance Data (3000K)

	R1	R2	R3	R4	R5	R6	R7	R8	R9	R10	R11	R12	R13	R14
A-line	94	96	96	93	92	93	94	86	66	88	93	75	94	96
	Clear	Clear + Micro Louvre	Clear + 23° (KKLN-03)	Clear + 23° (KKLN-03) + Micro Louvre	Clear + Asymmetric lens (KKLN-A2)	Diffused Cover	CRI	R9	Rf	Rg				
A-line	3656lm/m (1114lm/ft) 91.4lm/W	1054lm/m (321lm/ft) 26.4lm/W	2004lm/m (611lm/ft) 50.1lm/W	1060lm/m (323lm/ft) 26.5lm/W	3656lm/m (1114lm/ft) 91.4lm/W	1640lm/m (500lm/ft) 41lm/W	94	66	-	-				

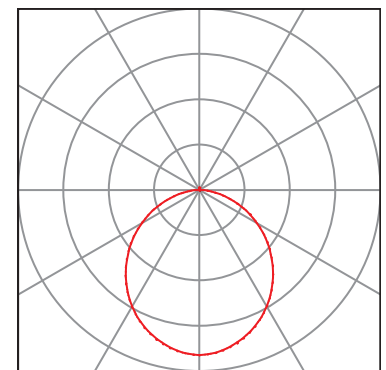
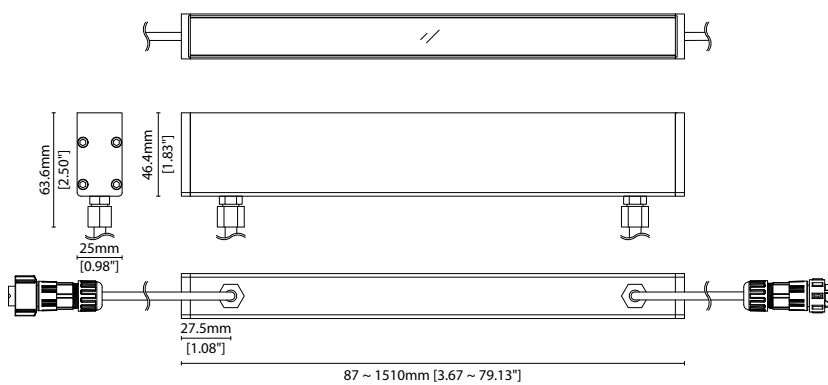

— C0 / C180 cd / 1000 lm — C90 / C270

Data derived from independent UKAS/IESNA LM-79-08 accredited testing of production samples.

Linear

MOMO-F A040 (40W)

Code Table



FIXTURE

Model	Finish	Cover ¹	Grade ²	LED	Colour (CCT)	Length Availability ³	IP	Cable Length	Power Feed ⁴	Input
MOMO-F MF	Silver Anodised SA	Clear B	A A	A040 040	2700K 27	m 97-1520mm 41.7mm increments	IP67 ⁵ 67	300mm/ 11.81" 0300	Single ø6.3mm sheath tail S00B	DC 24V g
		Clear + Micro Louvre K			3000K 30				Double ø6.3mm sheath tail D00B	
		Clear + 23° (KKLN-03) A			4000K 40	i 3.82-59.84in 1.51in increments			Single ø6.3mm sheath IP67 connector S67B	
		Clear + 23° (KKLN-03) + Micro Louvre AK				(Specify length code OR total run length)			Double ø6.3mm sheath IP67 connector D67B	
		Clear + Asymmetric lens (KKLN-A2) BA2								
		Diffused C								

¹ Refer to Cover/Lens Options on Options pages

² Refer to LED Grading Key on Specification sheet page

³ Refer to Length Availability List or enter total run length instead of length code

⁴ Refer to Power Feed Options on Options pages

⁵ Due to the clear, flush potted polyurethane top layer on IP67 MOMO-F a colour shift of +/-20K should be expected

Code Example:

MF	-	SA	-	C	-	A	-	040	-	30	-	m	-	520	-	67	-	0300	-	D00B	-	g
MOMO-F		Silver Anodised		Diffused		A		A040		3000K		520mm		IP67		300mm/11.81"		0300		Double ø6.3mm sheath tail		DC 24V

ACCESSORIES

Mounting Accessories

KKFR-03	Ground box
KKCP-11	Concealed clip

* Refer to Mounting accessories on Accessories pages

Connection Accessories

CN67-2P-0300	IP67 2 PIN male & female 300mm/11.81" pair
CN67-2P-1000	IP67 2 PIN male & female 1000mm/39.37" pair
CN67-2P-3000	IP67 2 PIN male & female 3000mm/118.11" pair

* Refer to Power feed on Accessories pages

Exterior Junction Boxes

KKJB-07	IP67 Slim J-Box
KKJB-07R	Potting Resin for IP67 Slim J-Box

* Refer to Exterior Junction Boxes on Accessories pages

PSU/Driver

0-10V/1-10V/DALI/DMX

* Refer to Driver/PSU Options page for details or provide requirement and KKDC to offer the suitable option

LED ENGINE VARIANTS (LED STRIP TYPE)

Colour	LED	Lumen/m	Lumen/ft	W/m	W/ft	Spec Doc	Length	Increment
Single CCT	R007	556	169	7	2.13	MOMO-F R007	103-2020mm (4.05-79.52in)	41.7mm (1.64in)
	R014	1137	346	14	4.27	MOMO-F R014	103-2020mm (4.05-79.52in)	41.7mm (1.64in)
	R020	1548	472	20	6.10	MOMO-F R020	103-2020mm (4.05-79.52in)	41.7mm (1.64in)
	R030	2280	695	30	9.14	MOMO-F R030	103-2020mm (4.05-79.52in)	41.7mm (1.64in)
	R207	1269	387	16	4.88	MOMO-F R207	103-2020mm (4.05-79.52in)	83.3mm (3.28in)
	A040	3656	1114	40	12.19	MOMO-F A040	97-1520mm (3.82-59.84in)	38.46mm (1.51in)
RGB	501	Red 124 Green 265 Blue 41 RGB 382	Red 38 Green 81 Blue 13 RGB 116	15.6	4.75	MOMO-F RGB	103-2020mm (4.05-79.52in)	83.3mm (3.28in)
RGBW	R201	971	296	20	6.10	MOMO-F RGBW	155-2030mm (6.10-79.92in)	62.5mm (2.46in)

* Performance data: A/s-line, clear cover, 3000K

Linear

MOMO-F A040 (40W)

Length Availability List



Length Code		Fixture Length ¹		LED Strip ²		End Cap Dimension ³		Wattage (W)	Output (lm)
Metric	Imperial(US)	Metric	Imperial(US)	Metric	Imperial(US)	Metric	Imperial(US)		3000K (Test Data)
m0097	i0004	97mm	3.82in	77mm	3.03in	10mm	0.39in	3.08	281
m0135	i0005	135mm	5.33in	115mm	4.54in	10mm	0.39in	4.62	422
m0174	i0007	174mm	6.84in	154mm	6.06in	10mm	0.39in	6.15	562
m0212	i0008	212mm	8.36in	192mm	7.57in	10mm	0.39in	7.69	703
m0251	i0010	251mm	9.87in	231mm	9.09in	10mm	0.39in	9.23	844
m0289	i0011	289mm	11.39in	269mm	10.60in	10mm	0.39in	10.77	984
m0328	i0013	328mm	12.90in	308mm	12.11in	10mm	0.39in	12.31	1125
m0366	i0014	366mm	14.42in	346mm	13.63in	10mm	0.39in	13.85	1266
m0405	i0016	405mm	15.93in	385mm	15.14in	10mm	0.39in	15.38	1406
m0443	i0017	443mm	17.44in	423mm	16.66in	10mm	0.39in	16.92	1547
m0482	i0019	482mm	18.96in	462mm	18.17in	10mm	0.39in	18.46	1687
m0520	i0020	520mm	20.47in	500mm	19.69in	10mm	0.39in	20.00	1828
m0558	i0022	558mm	21.99in	538mm	21.20in	10mm	0.39in	21.54	1969
m0597	i0024	597mm	23.50in	577mm	22.71in	10mm	0.39in	23.08	2109
m0635	i0025	635mm	25.02in	615mm	24.23in	10mm	0.39in	24.62	2250
m0674	i0027	674mm	26.53in	654mm	25.74in	10mm	0.39in	26.15	2390
m0712	i0028	712mm	28.04in	692mm	27.26in	10mm	0.39in	27.69	2531
m0751	i0030	751mm	29.56in	731mm	28.77in	10mm	0.39in	29.23	2672
m0789	i0031	789mm	31.07in	769mm	30.28in	10mm	0.39in	30.77	2812
m0828	i0033	828mm	32.59in	808mm	31.80in	10mm	0.39in	32.31	2953
m0866	i0034	866mm	34.10in	846mm	33.31in	10mm	0.39in	33.85	3094
m0905	i0036	905mm	35.61in	885mm	34.83in	10mm	0.39in	35.38	3234
m0943	i0037	943mm	37.13in	923mm	36.34in	10mm	0.39in	36.92	3375
m0982	i0039	982mm	38.64in	962mm	37.86in	10mm	0.39in	38.46	3515
m1020	i0040	1020mm	40.16in	1000mm	39.37in	10mm	0.39in	40.00	3656
m1058	i0042	1058mm	41.67in	1038mm	40.88in	10mm	0.39in	41.54	3797
m1097	i0043	1097mm	43.19in	1077mm	42.40in	10mm	0.39in	43.08	3937
m1135	i0045	1135mm	44.70in	1115mm	43.91in	10mm	0.39in	44.62	4078
m1174	i0046	1174mm	46.21in	1154mm	45.43in	10mm	0.39in	46.15	4218
m1212	i0048	1212mm	47.73in	1192mm	46.94in	10mm	0.39in	47.69	4359
m1251	i0049	1251mm	49.24in	1231mm	48.46in	10mm	0.39in	49.23	4500
m1289	i0051	1289mm	50.76in	1269mm	49.97in	10mm	0.39in	50.77	4640
m1328	i0052	1328mm	52.27in	1308mm	51.48in	10mm	0.39in	52.31	4781
m1366	i0054	1366mm	53.79in	1346mm	53.00in	10mm	0.39in	53.85	4922
m1405	i0055	1405mm	55.30in	1385mm	54.51in	10mm	0.39in	55.38	5062
m1443	i0057	1443mm	56.81in	1423mm	56.03in	10mm	0.39in	56.92	5203
m1482	i0058	1482mm	58.33in	1462mm	57.54in	10mm	0.39in	58.46	5343
m1520	i0060	1520mm	59.84in	1500mm	59.06in	10mm	0.39in	60.00	5484

¹ Actual total overall length of light fixture (LED strip + end caps + void/wire hole)

² Actual length of PCB strip

³ Actual length of 2x end caps

Linear

MOMO-F A040 (40W)

Length Availability List

KKDC

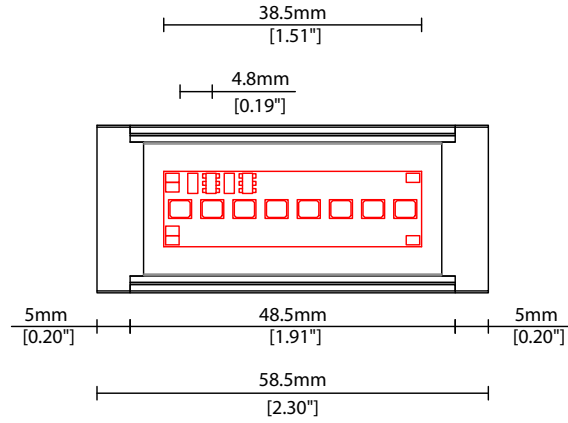

COVER/LENS OPTIONS

* Options are an integral part of the fixture ordering codes. Please refer to **Code Table** pages.



B Clear Cover
W25.0/H46.4mm (W0.98/H1.83")

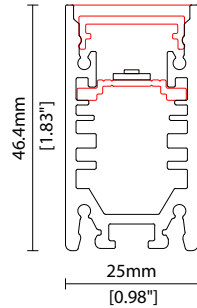

K Clear Cover + Micro louvre
W25.0/H46.4mm (W0.98/H1.83")

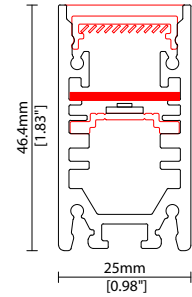

A Clear Cover + 23° (KKLN-03)
W25.0/H46.4mm (W0.98/H1.83")

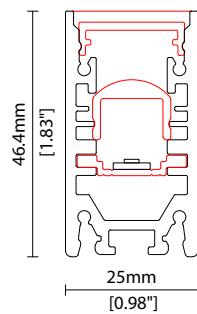

AK Clear Cover + 23° (KKLN-03) + Micro louvre
W25.0/H46.4mm (W0.98/H1.83")

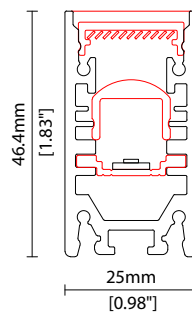

BA2 Clear Cover + Asymmetric lens (KKLN-A2)
W25.0/H46.4mm (W0.98/H1.83")

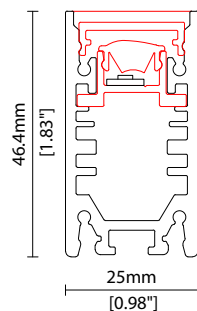

C Diffused Cover
W25.0/H46.4mm (W0.98/H1.83")

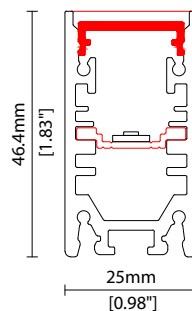

POWER FEED OPTIONS

0300 S00B 300mm (11.81") Single Ø6.3mm sheath tail

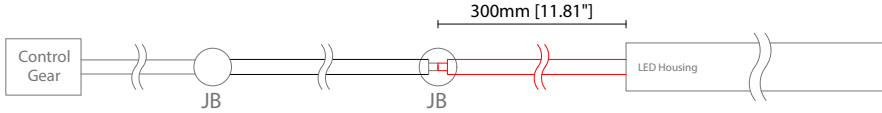

0300 D00B 300mm (11.81") Double Ø6.3mm sheath tail

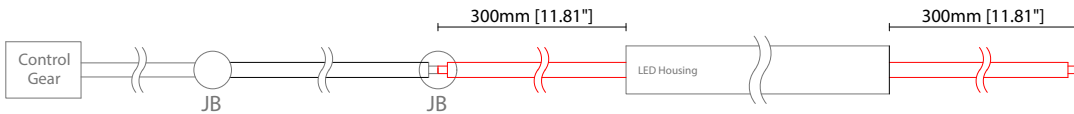

0300 S67B 300mm (11.81") Single Ø6.3mm sheath IP67 connector

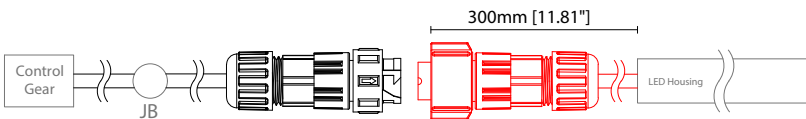

0300 D67B 300mm (11.81") Double Ø6.3mm sheath IP67 connector

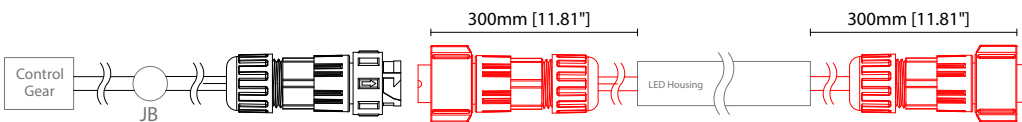

2 Pin Female Connector IP67

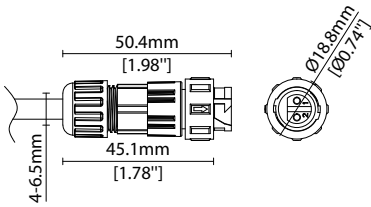

2 Pin Male Connector IP67

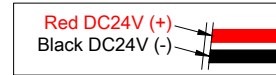
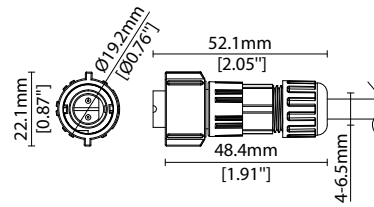

Key

Control Gear Power supply, sub-controllers & control systems

JB Junction box / cable connection

Linear

MOMO-F A040 (40W) Accessories

KKDÖ

MOUNTING ACCESSORIES

Note: Accessories are to be ordered separately with corresponding code shown below.



KKFR-03*
Ground box
Anodised aluminium finish
W37.6/H80.9mm (W1.48/H3.19")
* Specify length to match
MOMO-F

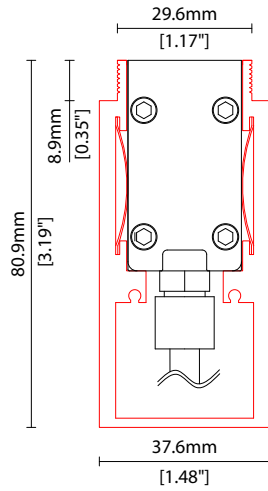

KKCP-11
Concealed clip
(allow 3 per metre/40in)
S/Steel finish
L20/W22/H28.1mm
(L0.79/W0.87/H1.11")

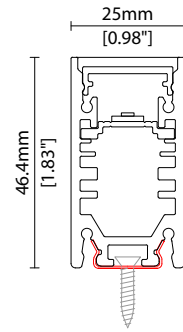

POWER FEED

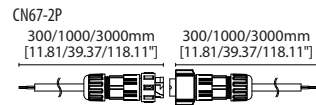

CN67-2P-0300 300mm (11.81in) pair
CN67-2P-1000 1000mm (39.37in) pair
CN67-2P-3000 3000mm (118.11in) pair

IP67
2 PIN male + female connector set

Linear

MOMO-F A040 (40W) Accessories

KKDC

EXTERIOR JUNCTION BOXES



KKJB-07

IP67 Slim J-Box
(including type A,B,C, D bushings)



KKJB-07R

Potting resin for IP67 Slim J-Box

KKDC CONTROL



IP20
Plastic housing
L170/W59/H29mm
(L6.69/W2.32/H1.14in)

KKDM-06 1-10V

visDIM dimmable sub-controller
(4 x 8A max @ 12-36V)



IP20
Plastic housing
L170/W53.4/H28mm
(L6.69/W2.10/H1.10in)

KKSC-05 DMX

visDIM dimmable sub-controller
(4 x 5A max @ 12-36V)



IP20
Plastic housing
L170/W59/H29mm
(L6.69/W2.32/H1.14in)

KKDL-02 DALI

visDIM dimmable sub-controller
(4 x 8A max @ 12-36V)



IP20
Plastic housing
L166/W53.4/H23mm
(L6.54/W2.10/H0.91in)

KKDL-03 DALI

visDIM dimmable sub-controller
(4 x 5A max @ 12-36V)

AVAILABLE PSU OPTIONS

Control Mode	PSU (Order Code)	Input Voltage AC	Output Voltage DC	Rated Output Current	Rated Power	Dim %	IP Rating
Switched	CEN-60-24	90-295V	24V	2.5A	60W	-	IP67
	HLG-60H-24	90-305V	24V	2.5A	60W	-	IP67
	HLG-100H-24	90-305V	24V	4.0A	100W	-	IP67
	HLG-150H-24	90-305V	24V	6.3A	150W	-	IP67
	HLG-240H-24	90-305V	24V	10A	240W	-	IP67
0-10V (1-10V)	PWM-40-24	90-305V	24V	1.67A	40W	100-0.15 (100-10)	IP67
	PWM-60-24	90-305V	24V	2.5A	60W	100-0.15 (100-10)	IP67
	PWM-90-24	90-305V	24V	3.67A	90W	100-0.15 (100-10)	IP67
	PWM-120-24	90-305V	24V	5.0A	120W	100-0.15 (100-10)	IP67
DALI	LIN100A1	120-277V	24V	1A per channel	100W	100-0.1	IP66/IP40
DMX RGB	LIN100A1	120-277V	24V	1.33A per channel	100W	100-0.1	IP66/IP40
DMX RGBW	LIN100A1	120-277A	24V	1A per channel	100W	100-0.1	IP66/IP40

Flicker Free Options - Combination of PSU+ sub-controller

Control Mode	PSU (Order Code)	Sub-controller (Order Code)	Input Voltage AC	Output Voltage DC	Rated Output Current	Rated Power	Dim %	IP Rating PSU/ Sub-controller
0-10V or 1-10V	CEN-60-24	KKDM-06	90-295V	24V	2.5A	60W	100-0.9	IP67/IP20
	HLG-60H-24	KKDM-06	90-295V	24V	2.5A	60W	100-0.9	IP67/IP20
	HLG-100H-24	KKDM-06	90-295V	24V	4.0A	100W	100-0.9	IP67/IP20
	HLG-150H-24	KKDM-06	90-295V	24V	6.3A	150W	100-0.9	IP67/IP20
	HLG-240H-24	KKDM-06	90-295V	24V	10.0A	240W	100-0.9	IP67/IP20
DALI	CEN-60-24	KKDL-02/03	90-295V	24V	2.5A	60W	100-0.1	IP67/IP20
	HLG-60H-24	KKDL-02/03	90-305V	24V	2.5A	60W	100-0.1	IP67/IP20
	HLG-100H-24	KKDL-02/03	90-305V	24V	4.0A	100W	100-0.1	IP67/IP20
	HLG-150H-24	KKDL-02/03	90-305V	24V	6.3A	150W	100-0.1	IP67/IP20
	HLG-240H-24	KKDL-02/03	90-305V	24V	10.0A	240W	100-0.1	IP67/IP20
DMX RGB	CEN-60-24	KKSC-05	90-295V	24V	2.5A	60W	100-0.9	IP67/IP20
	HLG-60H-24	KKSC-05	90-305V	24V	2.5A	60W	100-0.9	IP67/IP20
	HLG-100H-24	KKSC-05	90-305V	24V	4A	100W	100-0.9	IP67/IP20
	HLG-150H-24	KKSC-05	90-305V	24V	6.3A	150W	100-0.9	IP67/IP20
	HLG-240H-24	KKSC-05	90-305V	24V	10.0A	240W	100-0.9	IP67/IP20

¹ The items shown above cover the most frequently used specification but does not exhaust the possible options

² PSU and/or driver can be chosen from the table, or KKDC may recommend the best option upon receipt of the controls requirement and installation environment

³ Electrical shop drawing will include detailed information of PSU and relevant control drivers

⁴ Cut sheets are available on the controls section of www.kkdc.lighting or upon request