

Linear

MOMO-F R030

Fixture Guide

KKDÖ

Indoor/Outdoor | Recessed | Output up to 2280lm/m (695lm/ft)



Key applications

- ✓ Bathrooms
- ✓ Building facades
- ✓ Direct lighting
- ✓ Exterior
- ✓ In ground
- ✓ Interior
- ✓ Orientation lighting
- ✓ Pathways/driveways
- ✓ Uplighting
- ✓ Wall grazing
- ✓ Wallwashing
- ✓ Wet area

Key features

- ✓ Asymmetric lens
- ✓ Custom lengths
- ✓ Constant Voltage (CV)
- ✓ Diffusion: homogenous
- ✓ Direct view
- ✓ Extensive CCT range
- ✓ Glare control options
- ✓ IP67 waterproof
- ✓ Lens options

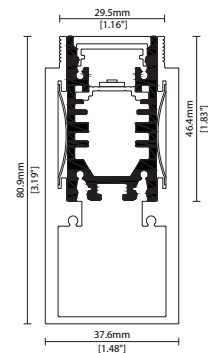

MOUNTING METHODS



KKFR-03 Ground box



KKCP-11 Concealed clip

Linear

MOMO-F R030

Specification sheet



Dimensions	H46.4/W25/L103-2020mm* (H1.83/W0.98/L4.05-79.52in*) *KKLN-A2 = 1020mm/40.16in max
PCB Cut-point	41.7mm increment/2000mm max* (1.64in increment/78.74in max*) *KKLN-A2 = 1000mm/39.37in max
LED Pitch	6.95mm-144LED/m (0.27in - 44LED/ft)
Chip	s-line k-line
Cover/Optics	Clear (100°)/Clear + Micro louvre/Clear + KKLN-01 lens (18°)/Clear + KKLN-01 lens (18°) + Micro louvre/Clear + KKLN-03 lens (23°)/Clear + KKLN-03 lens (23°) + Micro louvre/Clear + Asymmetric lens (KKLN-A2)/Diffused (95°)
CCT	s-line: 1900K/2100K/2300K/2500K/2700K/3000K/3500K/4000K/5000K k-line: 1900K/2100K/2300K/2500K/2700K/3000K/3500K/4000K/5000K
LED binning	s-line: 2-step MacAdam ellipse k-line: 3-step MacAdam ellipse
CRI	≥92
Lifetime	50,000 hours @ 25°C (50,000 hours @ 77°F)
Operating temp	T _a = -25 to 45°C (T _c max = 80.9°C) T _a = -13 to 113°F (T _c max = 178°F)
IP Rating	IP67
Finish	Silver anodised
Mounting	Ground recessed or surface mounted via concealed clips
Power feed	Sheathed hardwire tails or male/female connectors
Control	0-10V/1-10V/DMX/DALI



LED Grading Key

Exclusive Grade

s s-line*	*KKDC tuned CCT range
2-step CCT range	

Base Grade

k k-line	3-step commercial range Energy Star CCTs
-----------------	---------------------------------------------

Power consumption	Supply voltage	Supply current
30W/m (9.14W/ft)	24V DC	1.25A/m (0.38A/ft)

Performance Data (3000K)

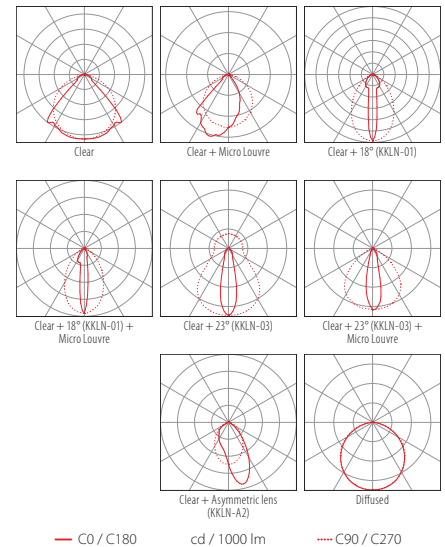
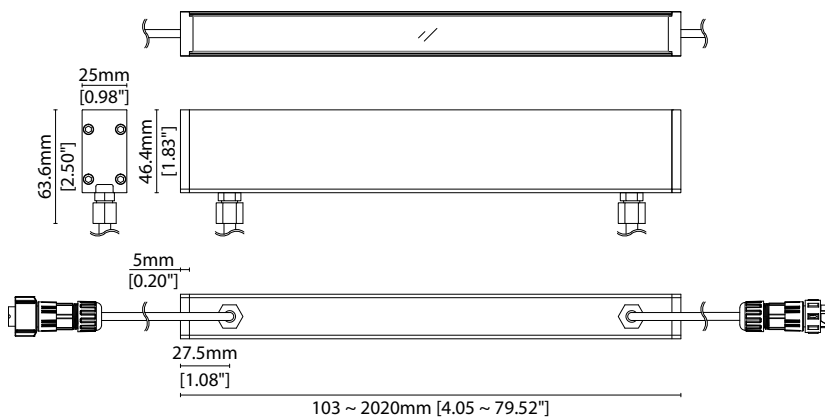

	R1	R2	R3	R4	R5	R6	R7	R8	R9	R10	R11	R12	R13	R14
k-line	93	97	97	90	91	94	91	82	61	91	89	75	94	98

	Clear	Clear + Micro Louvre	Clear + 18° (KKLN-01)	Clear + 18° (KKLN-01) + Micro Louvre	Clear + 23° (KKLN-03)	Clear + 23° (KKLN-03) + Micro Louvre	Clear + Asymmetric lens (KKLN-A2)	Diffused Cover	CRI	R9	Rf	Rg
s-line	2280lm/m (695lm/ft) 76.0lm/W	659lm/m (201lm/ft) 21.9lm/w	1100lm/m (335lm/ft) 36.7lm/W	560lm/m (171lm/ft) 18.7lm/W	1272lm/m (388lm/ft) 42.4lm/W	719lm/m (219lm/ft) 24.0lm/W	2248lm/m (685lm/ft) 74.9lm/W	820lm/m (250lm/ft) 27.3lm/W	93	62	-	-
k-line	2151lm/m (656lm/ft) 71.7lm/W	622lm/m (190lm/ft) 20.7lm/w	1038lm/m (316lm/ft) 34.6lm/W	528lm/m (161lm/ft) 17.6lm/W	1200lm/m (366lm/ft) 40lm/W	678lm/m (207lm/ft) 22.6lm/W	2121lm/m (646lm/ft) 70.7lm/W	774lm/m (236lm/ft) 25.8lm/W	92	61	-	-



Data derived from independent UKAS/IESNA LM-79-08 accredited testing of production samples.

FIXTURE

Model	Finish	Cover ¹	Grade ²	LED	Colour (CCT)	Length Availability ³	IP	Cable Length	Power Feed ⁴	Input										
MOMO-F	MF	Silver Anodised	SA	Clear	B	 s	R030	R030	1900K	19	m	103-2020mm 41.7mm increments	IP67 ⁵	67	300mm/ 11.81"	0300	Single ø6.3mm sheath tail	S00B	DC 24V	g
				Clear + Micro Louvre	K	 k			2100K	21								Double ø6.3mm sheath tail	D00B	
				Clear + 18° (KKLN-01)	P				2300K	23	i	4.05-79.52in 3.28in increments								
				Clear + 18° (KKLN-01) + Micro Louvre	U				2500K	25		(Specify length code OR total run length)						Single ø6.3mm sheath IP67 connector	S67B	
				Clear + 23° (KKLN-03)	A				2700K	27								Double ø6.3mm sheath IP67 connector	D67B	
				Clear + 23° (KKLN-03) + Micro Louvre	AK				3000K	30										
				Clear + Asymmetric lens (KKLN-A2)	BA2				3500K	35										
				Diffused	C				4000K	40										
									5000K	50										

¹ Refer to Cover/Lens Options on Options pages

² Refer to LED Grading Key on Specification sheet page

³ Refer to Length Availability List or enter total run length instead of length code

⁴ Refer to Power Feed Options on Options pages

⁵ Due to the clear, flush potted polyurethane top layer on IP67 MOMO-F a colour shift of +/-20K should be expected

Code Example:

MF	-	SA	-	C	-	s	-	R030	-	35	-	m	520	-	67	-	0300	-	D00B	-	g
MOMO-F		Silver Anodised		Diffused				R030		3500K		520mm		IP67		300mm/11.81"		Double ø6.3mm sheath tail		DC 24V	

ACCESSORIES

Mounting Accessories

KKFR-03	Ground box
KKCP-11	Concealed clip

* Refer to Mounting accessories on Accessories pages

Connection Accessories

CN67-2P-0300	IP67 2 PIN male & female 300mm/11.81" pair
CN67-2P-1000	IP67 2 PIN male & female 1000mm/39.37" pair
CN67-2P-3000	IP67 2 PIN male & female 3000mm/118.11" pair

* Refer to Power feed on Accessories pages

Exterior Junction Boxes

KKJB-07	IP67 Slim J-Box
KKJB-07R	Potting Resin for IP67 Slim J-Box

* Refer to Exterior Junction Boxes on Accessories pages

PSU/Driver

0-10V/1-10V/DALI/DMX

* Refer to Driver/PSU Options page for details or provide requirement and KKDC to offer the suitable option

LED ENGINE VARIANTS (LED STRIP TYPE)

Colour	LED	Lumen/m	Lumen/ft	W/m	W/ft	Spec Doc	Length	Increment
Single CCT	R007	556	169	7	2.13	MOMO-F R007	103-2020mm (4.05-79.52in)	41.7mm (1.64in)
	R014	1137	346	14	4.27	MOMO-F R014	103-2020mm (4.05-79.52in)	41.7mm (1.64in)
	R020	1548	472	20	6.10	MOMO-F R020	103-2020mm (4.05-79.52in)	41.7mm (1.64in)
	R030	2280	695	30	9.14	MOMO-F R030	103-2020mm (4.05-79.52in)	41.7mm (1.64in)
	R207	1269	387	16	4.88	MOMO-F R207	103-2020mm (4.05-79.52in)	83.3mm (3.28in)
RGB	A040	3656	1114	40	12.19	MOMO-F A040	97-1520mm (3.82-59.84in)	38.46mm (1.51in)
	501	Red 124 Green 265 Blue 41 RGB 382	Red 38 Green 81 Blue 13 RGB 116	15.6	4.75	MOMO-F RGB	103-2020mm (4.05-79.52in)	83.3mm (3.28in)
RGBW	R201	971	296	20	6.10	MOMO-F RGBW	155-2030mm (6.10-79.92in)	62.5mm (2.46in)

* Performance data: A/s-line, clear cover, 3000K

Linear

MOMO-F R030

Length Availability List



Length Code		Fixture Length ¹		LED Strip ²		End Cap Dimension ³		Wattage (W)	Output (lm)
Metric	Imperial(US)	Metric	Imperial(US)	Metric	Imperial(US)	Metric	Imperial(US)		3000K (Test Data)
m0103	i0004	103mm	4.07in	83mm	3.28in	10mm	0.39in	2.50	179
m0145	i0006	145mm	5.71in	125mm	4.92in	10mm	0.39in	3.75	269
m0187	i0007	187mm	7.35in	167mm	6.56in	10mm	0.39in	5.00	358
m0228	i0009	228mm	8.99in	208mm	8.20in	10mm	0.39in	6.25	448
m0270	i0011	270mm	10.63in	250mm	9.84in	10mm	0.39in	7.50	538
m0312	i0012	312mm	12.27in	292mm	11.48in	10mm	0.39in	8.75	627
m0353	i0014	353mm	13.91in	333mm	13.12in	10mm	0.39in	10.00	717
m0395	i0016	395mm	15.55in	375mm	14.76in	10mm	0.39in	11.25	807
m0437	i0017	437mm	17.19in	417mm	16.40in	10mm	0.39in	12.50	896
m0478	i0019	478mm	18.83in	458mm	18.04in	10mm	0.39in	13.75	986
m0520	i0020	520mm	20.47in	500mm	19.69in	10mm	0.39in	15.00	1075
m0562	i0022	562mm	22.11in	542mm	21.33in	10mm	0.39in	16.25	1165
m0603	i0024	603mm	23.75in	583mm	22.97in	10mm	0.39in	17.50	1255
m0645	i0025	645mm	25.39in	625mm	24.61in	10mm	0.39in	18.75	1344
m0687	i0027	687mm	27.03in	667mm	26.25in	10mm	0.39in	20.00	1434
m0728	i0029	728mm	28.67in	708mm	27.89in	10mm	0.39in	21.25	1524
m0770	i0030	770mm	30.31in	750mm	29.53in	10mm	0.39in	22.50	1613
m0812	i0032	812mm	31.96in	792mm	31.17in	10mm	0.39in	23.75	1703
m0853	i0034	853mm	33.60in	833mm	32.81in	10mm	0.39in	25.00	1792
m0895	i0035	895mm	35.24in	875mm	34.45in	10mm	0.39in	26.25	1882
m0937	i0037	937mm	36.88in	917mm	36.09in	10mm	0.39in	27.50	1972
m0978	i0039	978mm	38.52in	958mm	37.73in	10mm	0.39in	28.75	2061
m1020	i0040	1020mm	40.16in	1000mm	39.37in	10mm	0.39in	30.00	2151
m1062	i0042	1062mm	41.80in	1042mm	41.01in	10mm	0.39in	31.25	2241
m1103	i0043	1103mm	43.44in	1083mm	42.65in	10mm	0.39in	32.50	2330
m1145	i0045	1145mm	45.08in	1125mm	44.29in	10mm	0.39in	33.75	2420
m1187	i0047	1187mm	46.72in	1167mm	45.93in	10mm	0.39in	35.00	2509
m1228	i0048	1228mm	48.36in	1208mm	47.57in	10mm	0.39in	36.25	2599
m1270	i0050	1270mm	50.00in	1250mm	49.21in	10mm	0.39in	37.50	2689
m1312	i0052	1312mm	51.64in	1292mm	50.85in	10mm	0.39in	38.75	2778
m1353	i0053	1353mm	53.28in	1333mm	52.49in	10mm	0.39in	40.00	2868
m1395	i0055	1395mm	54.92in	1375mm	54.13in	10mm	0.39in	41.25	2958
m1437	i0057	1437mm	56.56in	1417mm	55.77in	10mm	0.39in	42.50	3047
m1478	i0058	1478mm	58.20in	1458mm	57.41in	10mm	0.39in	43.75	3137
m1520	i0060	1520mm	59.84in	1500mm	59.06in	10mm	0.39in	45.00	3226
m1562	i0061	1562mm	61.48in	1542mm	60.70in	10mm	0.39in	46.25	3316
m1603	i0063	1603mm	63.12in	1583mm	62.34in	10mm	0.39in	47.50	3406
m1645	i0065	1645mm	64.76in	1625mm	63.98in	10mm	0.39in	48.75	3495
m1687	i0066	1687mm	66.40in	1667mm	65.62in	10mm	0.39in	50.00	3585
m1728	i0068	1728mm	68.04in	1708mm	67.26in	10mm	0.39in	51.25	3675
m1770	i0070	1770mm	69.69in	1750mm	68.90in	10mm	0.39in	52.50	3764
m1812	i0071	1812mm	71.33in	1792mm	70.54in	10mm	0.39in	53.75	3854
m1853	i0073	1853mm	72.97in	1833mm	72.18in	10mm	0.39in	55.00	3943

MOMO-F R030

Length Availability List



Length Code		Fixture Length ¹		LED Strip ²		End Cap Dimension ³		Wattage (W)	Output (lm)
Metric	Imperial(US)	Metric	Imperial(US)	Metric	Imperial(US)	Metric	Imperial(US)		3000K (Test Data)
m1895	i0075	1895mm	74.61in	1875mm	73.82in	10mm	0.39in	56.25	4033
m1937	i0076	1937mm	76.25in	1917mm	75.46in	10mm	0.39in	57.50	4123
m1978	i0078	1978mm	77.89in	1958mm	77.10in	10mm	0.39in	58.75	4212
m2020	i0080	2020mm	79.53in	2000mm	78.74in	10mm	0.39in	60.00	4302

¹ Actual total overall length of light fixture (LED strip + end caps + void/wire hole)

² Actual length of PCB strip

³ Actual length of 2x end caps

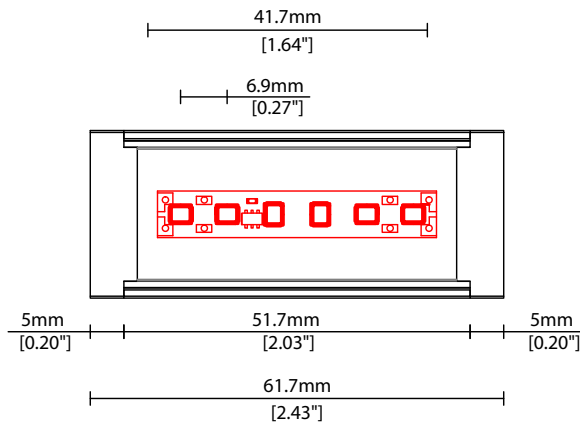

COVER/LENS OPTIONS

* Options are an integral part of the fixture ordering codes. Please refer to **Code Table** pages.



B Clear Cover
W25.0/H46.4mm (W0.98/H1.83")

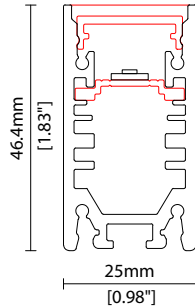

K Clear Cover + Micro louvre
W25.0/H46.4mm (W0.98/H1.83")

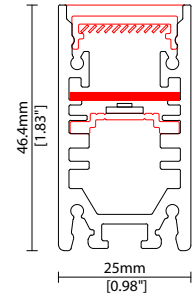

P Clear Cover 18° (KKLN-01)
W25.0/H46.4mm (W0.98/H1.83")

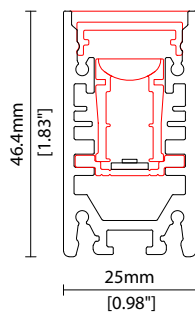

U Clear Cover + 18° (KKLN-01) + Micro louvre
W25.0/H46.4mm (W0.98/H1.83")

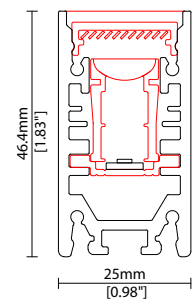

A Clear Cover + 23° (KKLN-03)
W25.0/H46.4mm (W0.98/H1.83")

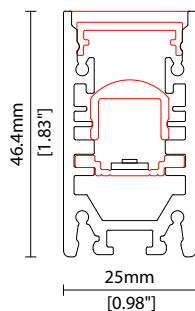

AK Clear Cover + 23° (KKLN-03) + Micro louvre
W25.0/H46.4mm (W0.98/H1.83")

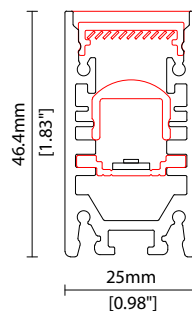

Linear

MOMO-F R030

Options

KKDC

COVER/LENS OPTIONS



BA2 Clear Cover +
Asymmetric lens (KKLN-A2)
W25.0/H46.4mm (W0.98/H1.83")

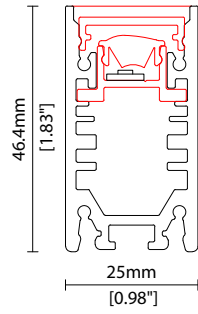

C Diffused Cover
W25.0/H46.4mm (W0.98/H1.83")

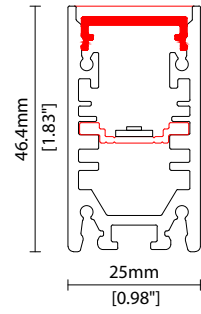

POWER FEED OPTIONS

0300 S00B 300mm (11.81") Single Ø6.3mm sheath tail

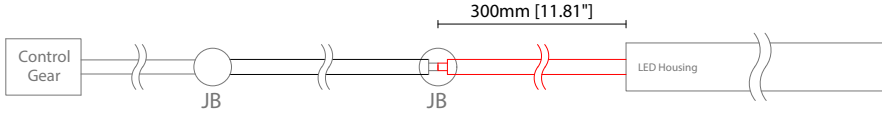

0300 D00B 300mm (11.81") Double Ø6.3mm sheath tail

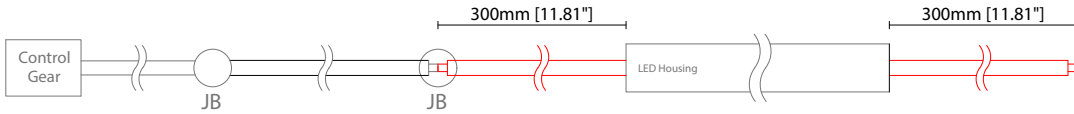

0300 S67B 300mm (11.81") Single Ø6.3mm sheath IP67 connector

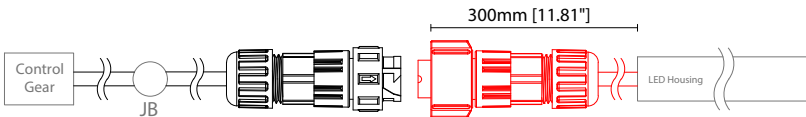

0300 D67B 300mm (11.81") Double Ø6.3mm sheath IP67 connector

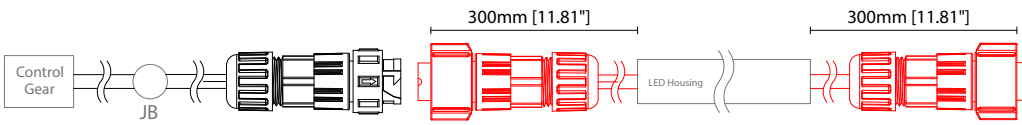

2 Pin Female Connector IP67

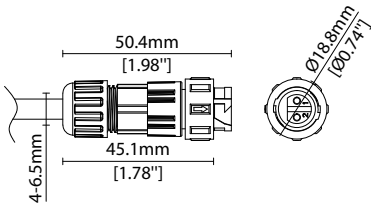

2 Pin Male Connector IP67

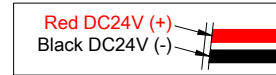
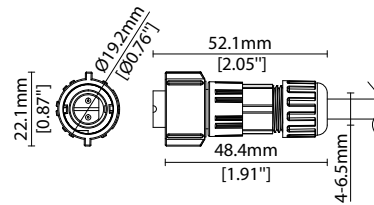

Key

- Control Gear Power supply, sub-controllers & control systems
- JB Junction box / cable connection

Linear

MOMO-F R030

Accessories



MOUNTING ACCESSORIES

Note: Accessories are to be ordered separately with corresponding code shown below.



KKFR-03*
Ground box
Anodised aluminium finish
W37.6/H80.9mm (W1.48/H3.19")

* Specify length to match
MOMO-F

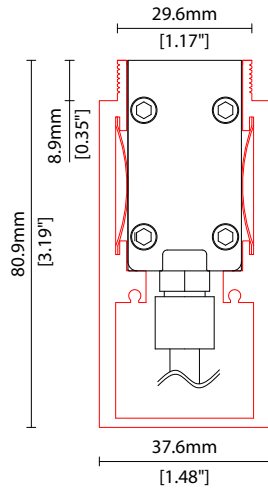

KKCP-11
Concealed clip
(allow 3 per metre/40in)
S/Steel finish
L20/W22/H28.1mm
(L0.79/W0.87/H1.11")

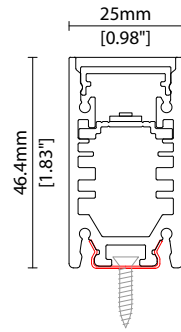

POWER FEED

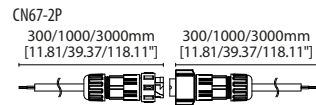

CN67-2P-0300 300mm (11.81in) pair
CN67-2P-1000 1000mm (39.37in) pair
CN67-2P-3000 3000mm (118.11in) pair

IP67
2 PIN male + female connector set

Linear

MOMO-F R030 Accessories

KKDC

EXTERIOR JUNCTION BOXES



KKJB-07

IP67 Slim J-Box
(including type A,B,C, D bushings)



KKJB-07R

Potting resin for IP67 Slim J-Box

KKDC CONTROL



IP20
Plastic housing
L170/W59/H29mm
(L6.69/W2.32/H1.14in)

KKDM-06 1-10V

visDIM dimmable sub-controller
(4 x 8A max @ 12-36V)



IP20
Plastic housing
L170/W53.4/H28mm
(L6.69/W2.10/H1.10in)

KKSC-05 DMX

visDIM dimmable sub-controller
(4 x 5A max @ 12-36V)



IP20
Plastic housing
L170/W59/H29mm
(L6.69/W2.32/H1.14in)

KKDL-02 DALI

visDIM dimmable sub-controller
(4 x 8A max @ 12-36V)



IP20
Plastic housing
L166/W53.4/H23mm
(L6.54/W2.10/H0.91in)

KKDL-03 DALI

visDIM dimmable sub-controller
(4 x 5A max @ 12-36V)

AVAILABLE PSU OPTIONS

Control Mode	PSU (Order Code)	Input Voltage AC	Output Voltage DC	Rated Output Current	Rated Power	Dim %	IP Rating
Switched	CEN-60-24	90-295V	24V	2.5A	60W	-	IP67
	HLG-60H-24	90-305V	24V	2.5A	60W	-	IP67
	HLG-100H-24	90-305V	24V	4.0A	100W	-	IP67
	HLG-150H-24	90-305V	24V	6.3A	150W	-	IP67
	HLG-240H-24	90-305V	24V	10A	240W	-	IP67
0-10V (1-10V)	PWM-40-24	90-305V	24V	1.67A	40W	100-0.15 (100-10)	IP67
	PWM-60-24	90-305V	24V	2.5A	60W	100-0.15 (100-10)	IP67
	PWM-90-24	90-305V	24V	3.67A	90W	100-0.15 (100-10)	IP67
	PWM-120-24	90-305V	24V	5.0A	120W	100-0.15 (100-10)	IP67
DALI	LIN100A1	120-277V	24V	1A per channel	100W	100-0.1	IP66/IP40
DMX RGB	LIN100A1	120-277V	24V	1.33A per channel	100W	100-0.1	IP66/IP40
DMX RGBW	LIN100A1	120-277A	24V	1A per channel	100W	100-0.1	IP66/IP40

Flicker Free Options - Combination of PSU+ sub-controller

Control Mode	PSU (Order Code)	Sub-controller (Order Code)	Input Voltage AC	Output Voltage DC	Rated Output Current	Rated Power	Dim %	IP Rating PSU/ Sub-controller
0-10V or 1-10V	CEN-60-24	KKDM-06	90-295V	24V	2.5A	60W	100-0.9	IP67/IP20
	HLG-60H-24	KKDM-06	90-295V	24V	2.5A	60W	100-0.9	IP67/IP20
	HLG-100H-24	KKDM-06	90-295V	24V	4.0A	100W	100-0.9	IP67/IP20
	HLG-150H-24	KKDM-06	90-295V	24V	6.3A	150W	100-0.9	IP67/IP20
	HLG-240H-24	KKDM-06	90-295V	24V	10.0A	240W	100-0.9	IP67/IP20
DALI	CEN-60-24	KKDL-02/03	90-295V	24V	2.5A	60W	100-0.1	IP67/IP20
	HLG-60H-24	KKDL-02/03	90-305V	24V	2.5A	60W	100-0.1	IP67/IP20
	HLG-100H-24	KKDL-02/03	90-305V	24V	4.0A	100W	100-0.1	IP67/IP20
	HLG-150H-24	KKDL-02/03	90-305V	24V	6.3A	150W	100-0.1	IP67/IP20
	HLG-240H-24	KKDL-02/03	90-305V	24V	10.0A	240W	100-0.1	IP67/IP20
DMX RGB	CEN-60-24	KKSC-05	90-295V	24V	2.5A	60W	100-0.9	IP67/IP20
	HLG-60H-24	KKSC-05	90-305V	24V	2.5A	60W	100-0.9	IP67/IP20
	HLG-100H-24	KKSC-05	90-305V	24V	4A	100W	100-0.9	IP67/IP20
	HLG-150H-24	KKSC-05	90-305V	24V	6.3A	150W	100-0.9	IP67/IP20
	HLG-240H-24	KKSC-05	90-305V	24V	10.0A	240W	100-0.9	IP67/IP20

¹ The items shown above cover the most frequently used specification but does not exhaust the possible options

² PSU and/or driver can be chosen from the table, or KKDC may recommend the best option upon receipt of the controls requirement and installation environment

³ Electrical shop drawing will include detailed information of PSU and relevant control drivers

⁴ Cut sheets are available on the controls section of www.kkdc.lighting or upon request