

Linear

MOMO-F RGB Fixture Guide

KKDC

Indoor/Outdoor | Recessed | RGB output



Key applications

- ✓ Bathrooms
- ✓ Pathways/driveways
- ✓ Building facades
- ✓ Special effect
- ✓ Direct lighting
- ✓ Uplighting
- ✓ Exterior
- ✓ Wall grazing
- ✓ In ground
- ✓ Wallwashing
- ✓ Interior
- ✓ Wet area
- ✓ Orientation lighting

Key features

- ✓ Custom lengths
- ✓ Glare control options
- ✓ Constant Voltage (CV)
- ✓ IP67 waterproof
- ✓ Diffusion: homogenous
- ✓ Lens options
- ✓ Direct view
- ✓ RGB

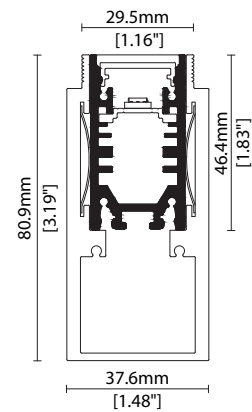

MOUNTING METHODS



KKFR-03 Ground box



KKCP-11 Concealed clip

Linear

MOMO-F RGB

Specification sheet



Dimensions	H46.4/W25/L103-2020mm (H1.83/W0.98/L4.05-79.52in)
PCB Cut-point	83.3mm increment/2000mm max (3.28in increment/78.74in max)
LED Pitch	13.9mm-72LED/m (0.55in - 22LED/ft)
Chip	RGB
Cover/Optics	Clear (100°)/Clear + Micro louvre/Clear KKLN-01 lens (18°)/Clear + KKLN-01 lens (18°) + Micro louvre/Clear + KKLN-03 lens (23°)/Clear + KKLN-03 lens (23°) + Micro louvre/Diffused (95°)
CCT	Red 620-625nm/Blue 455-460nm/Green 520-525nm
LED binning	5nm tolerance
CRI	N/A
Lifetime	50,000 hours @ 25°C (50,000 hours @ 77°F)
Operating temp	T _a = -20 to 60°C (T _c max = 70°C) T _a = -4 to 140°F (T _c max = 158°F)
IP Rating	IP67
Finish	Silver anodised
Mounting	Ground recessed or surface mounted via concealed clips
Power feed	Sheathed hardwire tails or male/female connectors
Control	DMX/DALI



Power consumption	Supply voltage	Supply current
15.6W/m (4.75W/ft)	24V DC	0.65A/m (0.20A/ft)

Clear	Clear + Micro Louvre	Clear + 18° (KKLN-01)	Clear + 18° (KKLN-01) + Micro Louvre	Clear + 23° (KKLN-03)	Clear + 23° (KKLN-03) + Micro Louvre	Diffused Cover
Red: 124lm/m (38lm/ft)	Red: 36lm/m (11lm/ft)	Red: 60lm/m (18lm/ft)	Red: 31lm/m (9lm/ft)	Red: 69lm/m (21lm/ft)	Red: 39lm/m (12lm/ft)	Red: 45lm/m (14lm/ft)
Green: 265lm/m (81lm/ft)	Green: 77lm/m (23lm/ft)	Green: 128lm/m (39lm/ft)	Green: 65lm/m (20lm/ft)	Green: 148lm/m (45lm/ft)	Green: 84lm/m (26lm/ft)	Green: 96lm/m (29lm/ft)
Blue: 41lm/m (13lm/ft)	Blue: 12lm/m (4lm/ft)	Blue: 20lm/m (6lm/ft)	Blue: 10lm/m (3lm/ft)	Blue: 23lm/m (7lm/ft)	Blue: 13lm/m (4lm/ft)	Blue: 15lm/m (5lm/ft)
RGB: 382lm/m (116lm/ft)	RGB: 110lm/m (34lm/ft)	RGB: 184lm/m (56lm/ft)	RGB: 94lm/m (29lm/ft)	RGB: 213lm/m (65lm/ft)	RGB: 120lm/m (37lm/ft)	RGB: 138lm/m (42lm/ft)

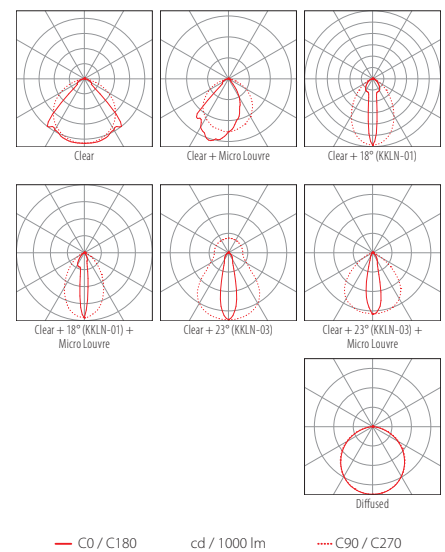
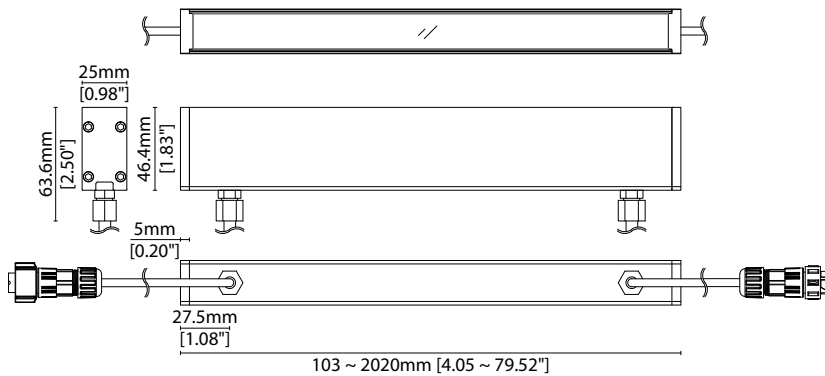

Data derived from production samples tested to UKAS/IESNA LM-79-08 standards.

FIXTURE

Model	Finish	Cover/Lens ¹	Grade	LED	Colour (CCT)	Length Availability ²	IP	Cable Length	Power Feed ³	Input
MOMO-F MF	Silver Anodised SA	Clear B Clear + Micro Louvre K Clear + 18° (KKLN-01) P Clear + 18° (KKLN-01) + Micro Louvre U Clear + 23° (KKLN-03) A Clear + 23° (KKLN-03) + Micro Louvre Diffused AK Diffused C	s	501 501	RGB RGB	m 103-2020mm 83mm increments i 4.05-79.52in 3.28in increments (Specify length code OR total run length)	IP67 ⁴ 67	300mm/ 11.81" 0300	Single ø6.3mm sheath tail S00B Double ø6.3mm sheath tail D00B Single ø6.3mm sheath IP67 connector S67B Double ø6.3mm sheath IP67 connector D67B	DC 24V g

¹ Refer to **Cover/Lens Options** on **Options** pages

² Refer to **Length Availability List** or enter total run length instead of length code

³ Refer to **Power Feed Options** on **Options** pages

⁴ Due to the clear, flush potted polyurethane top layer on IP67 MOMO-F a colour shift of +/-20K should be expected

Code Example:

MF	-	SA	-	C	-	s	-	501	-	RGB	-	m	520	-	67	-	0300	-	D67B	-	g
MOMO-F		Silver Anodised		Diffused				501		RGB		m	520mm		67		300mm/11.81"		Double ø6.3mm sheath IP67 connector		DC 24V

ACCESSORIES

Mounting Accessories

KKFR-03	Ground box
KKCP-11	Concealed clip

* Refer to **Mounting accessories** on **Accessories** pages

Connection Accessories

CN67-4P-0300	IP67 4 PIN LEDmix male & female 300mm/11.81" pair
CN67-4P-1000	IP67 4 PIN LEDmix male & female 1000mm/39.37" pair
CN67-4P-3000	IP67 4 PIN LEDmix male & female 3000mm/118.11" pair

* Refer to **Power feed** on **Accessories** pages

Exterior Junction Boxes

KKJB-07	IP67 Slim J-Box
KKJB-07R	Potting Resin for IP67 Slim J-Box

* Refer to **Exterior Junction Boxes** on **Accessories** pages

PSU/Driver

0-10V/1-10V/DALI/DMX

* Refer to **Driver/PSU Options** page for details or provide requirement and KKDC to offer the suitable option

LED ENGINE VARIANTS (LED STRIP TYPE)

Colour	LED	Lumen/m	Lumen/ft	W/m	W/ft	Spec Doc	Length	Increment
Single CCT	R007	556	169	7	2.13	MOMO-F R007	103-2020mm (4.05-79.52in)	41.7mm (1.64in)
	R014	1137	346	14	4.27	MOMO-F R014	103-2020mm (4.05-79.52in)	41.7mm (1.64in)
	R020	1548	472	20	6.10	MOMO-F R020	103-2020mm (4.05-79.52in)	41.7mm (1.64in)
	R030	2280	695	30	9.14	MOMO-F R030	103-2020mm (4.05-79.52in)	41.7mm (1.64in)
	R207	1269	387	16	4.88	MOMO-F R207	103-2020mm (4.05-79.52in)	83.3mm (3.28in)
	A040	3656	1114	40	12.19	MOMO-F A040	97-1520mm (3.82-59.84in)	38.46mm (1.51in)
RGB	501	Red 124 Green 265 Blue 41 RGB 382	Red 38 Green 81 Blue 13 RGB 116	15.6	4.75	MOMO-F RGB	103-2020mm (4.05-79.52in)	83.3mm (3.28in)
RGBW	R201	971	296	20	6.10	MOMO-F RGBW	155-2030mm (6.10-79.92in)	62.5mm (2.46in)

* Performance data: RGB, clear cover

MOMO-F RGB

Length Availability List

Length Code		Fixture Length ¹		LED Strip ²		End Cap Dimension ³		Wattage (W)	Output (lm)			
Metric	Imperial(US)	Metric	Imperial(US)	Metric	Imperial(US)	Metric	Imperial(US)		R	G	B	W
m0103	i0004	103mm	4.07in	83mm	3.28in	10mm	0.39in	1.30	10	22	4	32
m0187	i0007	187mm	7.35in	167mm	6.56in	10mm	0.39in	2.60	21	44	7	64
m0270	i0011	270mm	10.63in	250mm	9.84in	10mm	0.39in	3.90	31	66	11	96
m0353	i0014	353mm	13.91in	333mm	13.12in	10mm	0.39in	5.20	42	89	14	128
m0437	i0017	437mm	17.19in	417mm	16.41in	10mm	0.39in	6.50	52	111	18	160
m0520	i0020	520mm	20.47in	500mm	19.69in	10mm	0.39in	7.80	62	133	21	191
m0603	i0024	603mm	23.76in	583mm	22.97in	10mm	0.39in	9.10	73	155	25	223
m0687	i0027	687mm	27.04in	667mm	26.25in	10mm	0.39in	10.40	83	177	28	255
m0770	i0030	770mm	30.32in	750mm	29.53in	10mm	0.39in	11.70	94	199	32	287
m0853	i0034	853mm	33.60in	833mm	32.81in	10mm	0.39in	13.00	104	222	35	319
m0937	i0037	937mm	36.88in	917mm	36.09in	10mm	0.39in	14.30	114	244	39	351
m1020	i0040	1020mm	40.16in	1000mm	39.37in	10mm	0.39in	15.60	125	266	42	383
m1103	i0043	1103mm	43.44in	1083mm	42.65in	10mm	0.39in	16.90	135	288	46	415
m1187	i0047	1187mm	46.72in	1167mm	45.94in	10mm	0.39in	18.20	146	310	49	447
m1270	i0050	1270mm	50.00in	1250mm	49.22in	10mm	0.39in	19.50	156	332	53	479
m1353	i0053	1353mm	53.29in	1333mm	52.50in	10mm	0.39in	20.80	166	355	56	511
m1437	i0057	1437mm	56.57in	1417mm	55.78in	10mm	0.39in	22.10	177	377	60	543
m1520	i0060	1520mm	59.85in	1500mm	59.06in	10mm	0.39in	23.40	187	399	63	574
m1603	i0063	1603mm	63.13in	1583mm	62.34in	10mm	0.39in	24.70	198	421	67	606
m1687	i0066	1687mm	66.41in	1667mm	65.62in	10mm	0.39in	26.00	208	443	70	638
m1770	i0070	1770mm	69.69in	1750mm	68.90in	10mm	0.39in	27.30	218	465	74	670
m1853	i0073	1853mm	72.97in	1833mm	72.18in	10mm	0.39in	28.60	229	488	77	702
m1937	i0076	1937mm	76.25in	1917mm	75.47in	10mm	0.39in	29.90	239	510	81	734
m2020	i0080	2020mm	79.53in	2000mm	78.75in	10mm	0.39in	31.20	250	532	84	766

¹ Actual total overall length of light fixture (LED strip + end caps + void/wire hole)

² Actual length of PCB strip

³ Actual length of 2x end caps

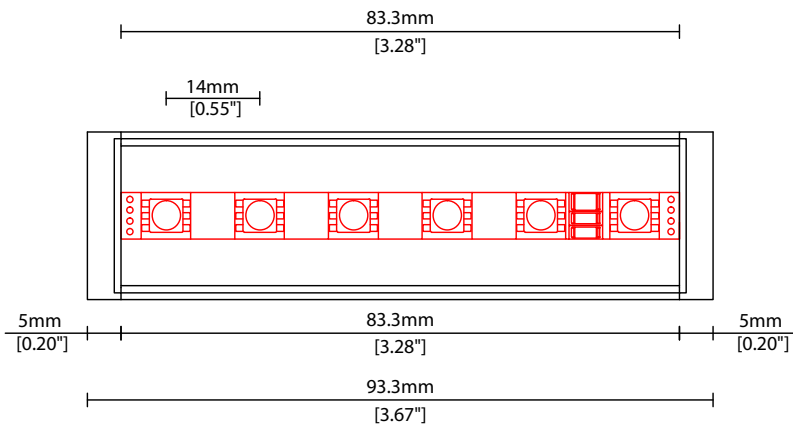

COVER/LENS OPTIONS

* Options are an integral part of the fixture ordering codes. Please refer to **Code Table** pages.



B Clear Cover
W25.0/H46.4mm (W0.98/H1.83")

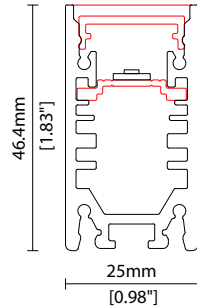

K Clear Cover + Micro louvre
W25.0/H46.4mm (W0.98/H1.83")

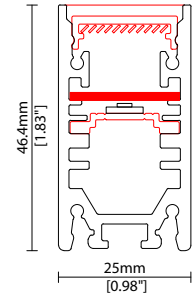

P Clear Cover + 18° (KKLN-01)
W25.0/H46.4mm (W0.98/H1.83")

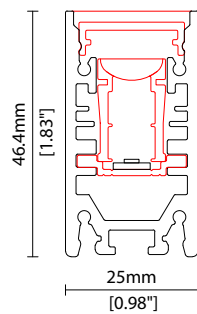

U Clear Cover + 18° (KKLN-01) + Micro louvre
W25.0/H46.4mm (W0.98/H1.83")

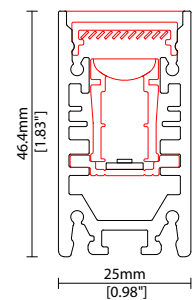

A Clear Cover + 23° (KKLN-03)
W25.0/H46.4mm (W0.98/H1.83")

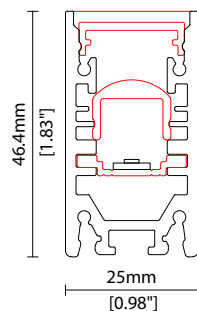

AK Clear Cover + 23° (KKLN-03) + Micro louvre
W25.0/H46.4mm (W0.98/H1.83")

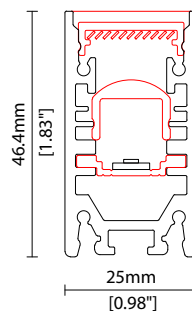



MOMO-F RGB Options



COVER/LENS OPTIONS



C Diffused Cover
W25.0/H46.4mm (W0.98/H1.83")

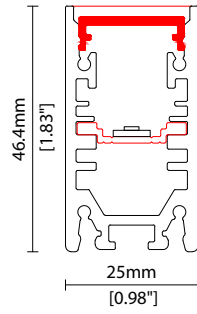

POWER FEED OPTIONS

0300 S00B 300mm (11.81") Single Ø6.3mm sheath tail

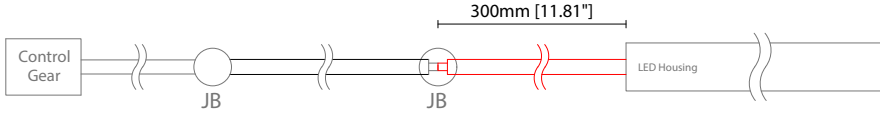

0300 D00B 300mm (11.81") Double Ø6.3mm sheath tail

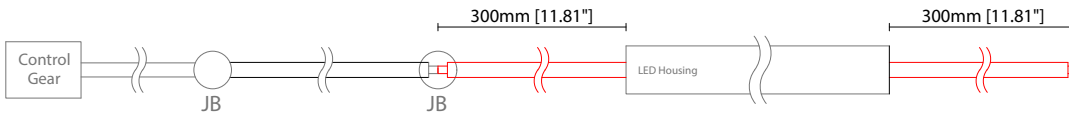

0300 S67B 300mm (11.81") Single Ø6.3mm sheath IP67 connector

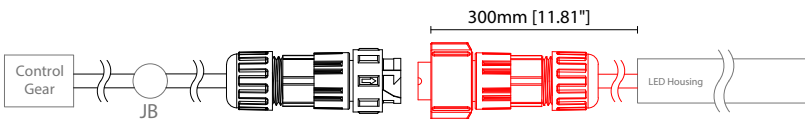

0300 D67B 300mm (11.81") Double Ø6.3mm sheath IP67 connector

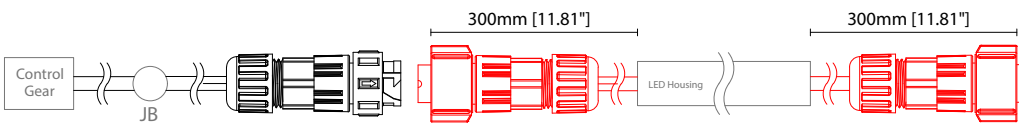

4 Pin RGB Female Connector IP67

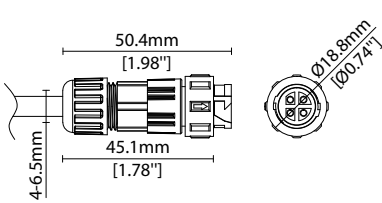

4 Pin RGB Male Connector IP67

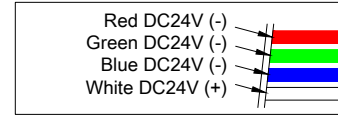
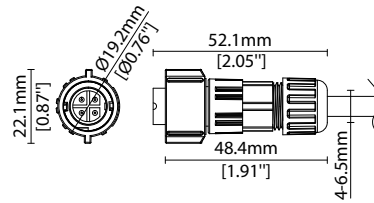

Key

Control Gear Power supply, sub-controllers & control systems

JB Junction box / cable connection

Linear

MOMO-F RGB Accessories



MOUNTING ACCESSORIES

Note: Accessories are to be ordered separately with corresponding code shown below.



KKFR-03*
Ground box
Anodised aluminium finish
W37.6/H80.9mm (W1.48/H3.19")

* Specify length to match
MOMO-F

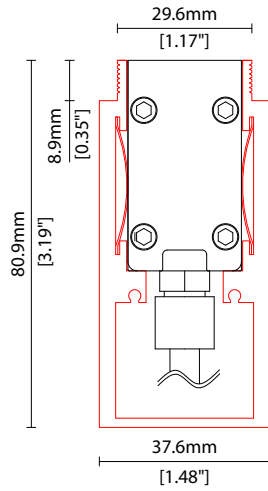

KKCP-11
Concealed clip
(allow 3 per metre/40in)
S/Steel finish
L20/W22/H28.1mm
(L0.79/W0.87/H1.11")

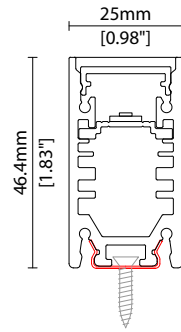

POWER FEED

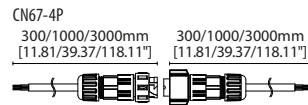

CN67-4P-0300 300mm (11.81in) pair
CN67-4P-1000 1000mm (39.37in) pair
CN67-4P-3000 3000mm (118.11in) pair

IP67

4 PIN male + female (RGB/LEDmix) connector set

EXTERIOR JUNCTION BOXES



KKJB-07

IP67 Slim J-Box
(including type A,B,C, D bushings)



KKJB-07R

Potting resin for IP67 Slim J-Box

KKDC CONTROL



KKDM-06 1-10V

visDIM dimmable sub-controller
(4 x 8A max @ 12-36V)

IP20
Plastic housing
L170/W59/H29mm
(L6.69/W2.32/H1.14in)



KKSC-05 DMX

visDIM dimmable sub-controller
(4 x 5A max @ 12-36V)

IP20
Plastic housing
L170/W53.4/H28mm
(L6.69/W2.10/H1.10in)



KKDL-02 DALI

visDIM dimmable sub-controller
(4 x 8A max @ 12-36V)

IP20
Plastic housing
L170/W59/H29mm
(L6.69/W2.32/H1.14in)



KKDL-03 DALI

visDIM dimmable sub-controller
(4 x 5A max @ 12-36V)

IP20
Plastic housing
L166/W53.4/H23mm
(L6.54/W2.10/H0.91in)

AVAILABLE PSU OPTIONS

Control Mode	PSU (Order Code)	Input Voltage AC	Output Voltage DC	Rated Output Current	Rated Power	Dim %	IP Rating
Switched	CEN-60-24	90-295V	24V	2.5A	60W	-	IP67
	HLG-60H-24	90-305V	24V	2.5A	60W	-	IP67
	HLG-100H-24	90-305V	24V	4.0A	100W	-	IP67
	HLG-150H-24	90-305V	24V	6.3A	150W	-	IP67
	HLG-240H-24	90-305V	24V	10A	240W	-	IP67
0-10V (1-10V)	PWM-40-24	90-305V	24V	1.67A	40W	100-0.15 (100-10)	IP67
	PWM-60-24	90-305V	24V	2.5A	60W	100-0.15 (100-10)	IP67
	PWM-90-24	90-305V	24V	3.67A	90W	100-0.15 (100-10)	IP67
	PWM-120-24	90-305V	24V	5.0A	120W	100-0.15 (100-10)	IP67
DALI	LIN100A1	120-277V	24V	1A per channel	100W	100-0.1	IP66/IP40
DMX RGB	LIN100A1	120-277V	24V	1.33A per channel	100W	100-0.1	IP66/IP40
DMX RGBW	LIN100A1	120-277A	24V	1A per channel	100W	100-0.1	IP66/IP40

Flicker Free Options - Combination of PSU+ sub-controller

Control Mode	PSU (Order Code)	Sub-controller (Order Code)	Input Voltage AC	Output Voltage DC	Rated Output Current	Rated Power	Dim %	IP Rating PSU/ Sub-controller
0-10V or 1-10V	CEN-60-24	KKDM-06	90-295V	24V	2.5A	60W	100-0.9	IP67/IP20
	HLG-60H-24	KKDM-06	90-295V	24V	2.5A	60W	100-0.9	IP67/IP20
	HLG-100H-24	KKDM-06	90-295V	24V	4.0A	100W	100-0.9	IP67/IP20
	HLG-150H-24	KKDM-06	90-295V	24V	6.3A	150W	100-0.9	IP67/IP20
	HLG-240H-24	KKDM-06	90-295V	24V	10.0A	240W	100-0.9	IP67/IP20
DALI	CEN-60-24	KKDL-02/03	90-295V	24V	2.5A	60W	100-0.1	IP67/IP20
	HLG-60H-24	KKDL-02/03	90-305V	24V	2.5A	60W	100-0.1	IP67/IP20
	HLG-100H-24	KKDL-02/03	90-305V	24V	4.0A	100W	100-0.1	IP67/IP20
	HLG-150H-24	KKDL-02/03	90-305V	24V	6.3A	150W	100-0.1	IP67/IP20
	HLG-240H-24	KKDL-02/03	90-305V	24V	10.0A	240W	100-0.1	IP67/IP20
DMX RGB	CEN-60-24	KKSC-05	90-295V	24V	2.5A	60W	100-0.9	IP67/IP20
	HLG-60H-24	KKSC-05	90-305V	24V	2.5A	60W	100-0.9	IP67/IP20
	HLG-100H-24	KKSC-05	90-305V	24V	4A	100W	100-0.9	IP67/IP20
	HLG-150H-24	KKSC-05	90-305V	24V	6.3A	150W	100-0.9	IP67/IP20
	HLG-240H-24	KKSC-05	90-305V	24V	10.0A	240W	100-0.9	IP67/IP20

¹ The items shown above cover the most frequently used specification but does not exhaust the possible options

² PSU and/or driver can be chosen from the table, or KKDC may recommend the best option upon receipt of the controls requirement and installation environment

³ Electrical shop drawing will include detailed information of PSU and relevant control drivers

⁴ Cut sheets are available on the controls section of www.kkdc.lighting or upon request