

MiMi Glow 008

Specification sheet



Dimension	H15/W13/L103.3-2020mm (H0.59/W0.51/L4.07-79.53in)
PCB increment	41.7mm increment/2000mm max (1.64in increment/78.74in max)
LED pitch	6.95mm (0.27in)
Chip	k-line Samsung
Beam angle	86° (Diffused Cover)
Colours	k-line 1900K/2100K/2500K/2700K/3000K/3500K/4000K/5000K
Bin/Step	k-line 3-step MacAdam ellipse
CRI	≥ 90
Lifetime	50,000 hours @ 25°C (50,000 hours @ 77°F)
Operating temp	T _a = -25 to 50°C (T _c max = 76°C) T _a = -13 to 122°F (T _c max = 168.8°F)
IP rating	IP54/IP67
Finish	Silver anodised
Cover/lens	Diffused
Mounting	Surface mounting lock clip or adjustable bracket
Power feed	Sheathed hardwire tails or male/female connectors
Control	0-10V/1-10V/DMX/DALI



LED Grading Key

Base Grade

- k-line**
3-step commercial range
Energy Star CCTs

PERFORMANCE DATA @ 3000K

Power Consumption	Supply voltage	Supply current
20W/m (6.09W/ft)	24V DC	0.83A/m (0.25A/ft)

Colour Rendering Index (CRI)

	R1	R2	R3	R4	R5	R6	R7	R8	R9	R10	R11	R12	R13	R14
k-line	94	97	98	93	93	96	92	83	60	93	94	82	95	99

Diffused Cover

		CRI	R9	Rf	Rg
k-line	583lm/m (177lm/ft) 29.3lm/W	92	60	-	-

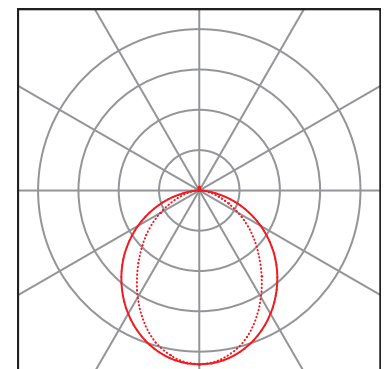
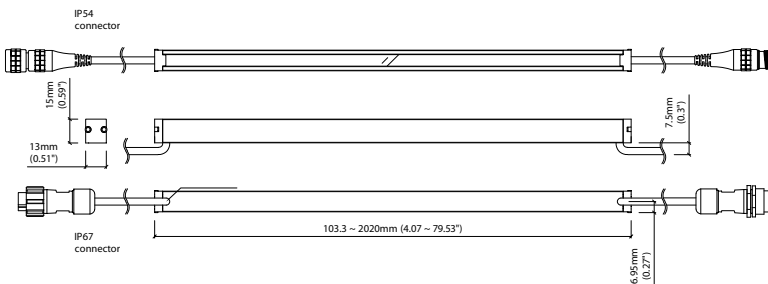

— C0 / C180 cd / 1000 lm - - - C90 / C270

Data derived from independent UKAS / IESNA LM-79-08 accredited testing of production samples.

MiMi Glow 008

Length Availability List



Length Code		Fixture Length ¹		LED Strip ²		End Cap Dimension ³		Wattage (W)	Output (lm)	
Metric	Imperial(US)	Metric	Imperial(US)	Metric	Imperial(US)	Metric	Imperial(US)		3000K (Test Data)	Range Data
m0056	i0002	56mm	2.19in	42mm	1.64in	4mm	0.16in	0.45	22	16-23
m0097	i0004	97mm	3.83in	83mm	3.28in	4mm	0.16in	0.91	45	32-47
m0139	i0005	139mm	5.47in	125mm	4.92in	4mm	0.16in	1.36	67	48-70
m0181	i0007	181mm	7.11in	167mm	6.56in	4mm	0.16in	1.82	90	64-94
m0222	i0009	222mm	8.75in	208mm	8.20in	4mm	0.16in	2.27	112	80-117
m0264	i0010	264mm	10.39in	250mm	9.84in	4mm	0.16in	2.73	135	95-140
m0306	i0012	306mm	12.04in	292mm	11.48in	4mm	0.16in	3.18	157	111-164
m0347	i0014	347mm	13.68in	333mm	13.12in	4mm	0.16in	3.63	180	127-187
m0389	i0015	389mm	15.32in	375mm	14.76in	4mm	0.16in	4.09	202	143-210
m0431	i0017	431mm	16.96in	417mm	16.41in	4mm	0.16in	4.54	225	159-234
m0472	i0019	472mm	18.60in	458mm	18.05in	4mm	0.16in	5.00	247	175-257
m0514	i0020	514mm	20.24in	500mm	19.69in	4mm	0.16in	5.45	270	191-281
m0556	i0022	556mm	21.88in	542mm	21.33in	4mm	0.16in	5.90	292	207-304
m0597	i0024	597mm	23.52in	583mm	22.97in	4mm	0.16in	6.36	315	223-327
m0639	i0025	639mm	25.16in	625mm	24.61in	4mm	0.16in	6.81	337	239-351
m0681	i0027	681mm	26.80in	667mm	26.25in	4mm	0.16in	7.27	360	255-374
m0722	i0028	722mm	28.44in	708mm	27.89in	4mm	0.16in	7.72	382	271-397
m0764	i0030	764mm	30.08in	750mm	29.53in	4mm	0.16in	8.18	405	286-421
m0806	i0032	806mm	31.72in	792mm	31.17in	4mm	0.16in	8.63	427	302-444
m0848	i0034	848mm	33.36in	833mm	32.80in	4mm	0.16in	9.08	450	318-468
m0889	i0035	889mm	35.00in	875mm	34.45in	4mm	0.16in	9.54	472	334-491
m0931	i0037	931mm	36.64in	917mm	36.09in	4mm	0.16in	9.99	495	350-514
m0972	i0038	972mm	38.28in	958mm	37.73in	4mm	0.16in	10.45	517	366-538
m1014	i0040	1014mm	39.92in	1000mm	39.37in	4mm	0.16in	10.90	540	382-561
m1056	i0042	1056mm	41.56in	1042mm	41.01in	4mm	0.16in	11.35	562	398-585
m1097	i0043	1097mm	43.21in	1083mm	42.65in	4mm	0.16in	11.81	585	414-608
m1139	i0045	1139mm	44.85in	1125mm	44.29in	4mm	0.16in	12.26	607	430-631
m1181	i0046	1181mm	46.49in	1167mm	45.94in	4mm	0.16in	12.72	629	446-655
m1222	i0048	1222mm	48.13in	1208mm	47.58in	4mm	0.16in	13.17	652	462-678
m1264	i0050	1264mm	49.77in	1250mm	49.22in	4mm	0.16in	13.63	674	477-701
m1306	i0051	1306mm	51.41in	1292mm	50.86in	4mm	0.16in	14.08	697	493-725
m1347	i0053	1347mm	53.05in	1333mm	52.50in	4mm	0.16in	14.53	719	509-748
m1389	i0055	1389mm	54.69in	1375mm	54.14in	4mm	0.16in	14.99	742	525-772
m1431	i0056	1431mm	56.33in	1417mm	55.78in	4mm	0.16in	15.44	764	541-795
m1472	i0058	1472mm	57.97in	1458mm	57.42in	4mm	0.16in	15.90	787	557-818
m1514	i0060	1514mm	59.61in	1500mm	59.06in	4mm	0.16in	16.35	809	573-842
m1556	i0061	1556mm	61.25in	1542mm	60.70in	4mm	0.16in	16.80	832	589-865
m1597	i0063	1597mm	62.89in	1583mm	62.34in	4mm	0.16in	17.26	854	605-888
m1639	i0065	1639mm	64.53in	1625mm	63.98in	4mm	0.16in	17.71	877	621-912
m1681	i0066	1681mm	66.17in	1667mm	65.62in	4mm	0.16in	18.17	899	637-935
m1722	i0068	1722mm	67.81in	1708mm	67.26in	4mm	0.16in	18.62	922	652-959
m1764	i0069	1764mm	69.45in	1750mm	68.90in	4mm	0.16in	19.08	944	668-982
m1806	i0071	1806mm	71.09in	1792mm	70.54in	4mm	0.16in	19.53	967	684-1005

No Data yet for this product

MiMi Glow 008

Length Availability List



Length Code		Fixture Length ¹		LED Strip ²		End Cap Dimension ³		Wattage (W)	Output (lm)	
Metric	Imperial(US)	Metric	Imperial(US)	Metric	Imperial(US)	Metric	Imperial(US)		3000K (Test Data)	Range Data
m1847	i0073	1847mm	72.74in	1833mm	72.18in	4mm	0.16in	19.98	989	700-1029
m1889	i0074	1889mm	74.38in	1875mm	73.82in	4mm	0.16in	20.44	1012	716-1052
m1931	i0076	1931mm	76.02in	1917mm	75.47in	4mm	0.16in	20.89	1034	732-1076
m1972	i0078	1972mm	77.66in	1958mm	77.11in	4mm	0.16in	21.35	1057	748-1099
m2014	i0079	2014mm	79.30in	2000mm	78.75in	4mm	0.16in	21.80	1079	764-1122

¹ Length of fixture including aluminium extrusion and end clamps

² Fixture without clamps available in this length upon request

³ Overall dimension including both end caps and internal wiring space

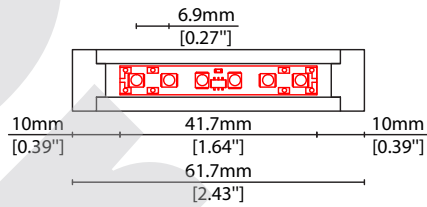

No Data yet for this product

MOUNTING OPTIONS

Note: Accessories are to be ordered separately with corresponding code shown below.



KKCP-14

Lock clip (allow 2 per metre/40in)
S/Steel finish

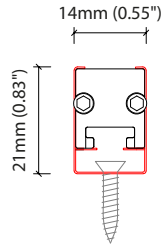

KKBK-24

Adjustable bracket
(allow 2 per metre/40in)
S/Steel finish

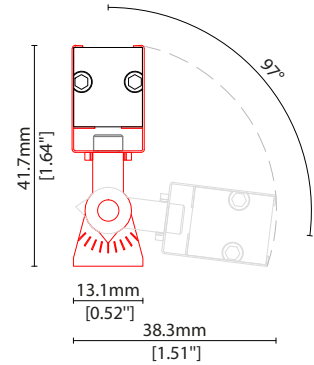

CONNECTORS

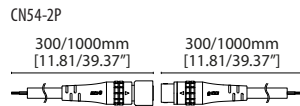

IP54

CN54-2P-0300 300mm (11.81in) pair
CN54-2P-1000 1000mm (39.37in) pair
IP54
2 PIN male + female connector set

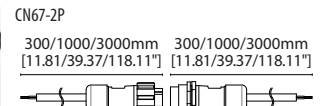

IP67

CN67-2P-0300 300mm (11.81in) pair
CN67-2P-1000 1000mm (39.37in) pair
CN67-2P-3000 3000mm (118.11in) pair
IP67
2 PIN male + female connector set

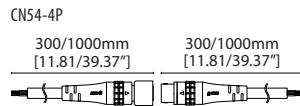

IP54

CN54-4P-0300 300mm (11.81in) pair
CN54-4P-1000 1000mm (39.37in) pair
IP54
4 PIN male + female (RGB/LEDmix) connector set

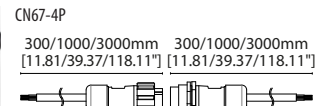

IP67

CN67-4P-0300 300mm (11.81in) pair
CN67-4P-1000 1000mm (39.37in) pair
CN67-4P-3000 3000mm (118.11in) pair
IP67
4 PIN male + female (RGB/LEDmix) connector set

Linear

MiMi Glow 008 Accessories

KKDC

EXTERIOR JUNCTION BOXES



KKJB-07

IP67 Slim J-Box
(including type A,B,C, D bushings)



KKJB-07R

Potting resin for IP67 Slim J-Box

KKDC CONTROL



IP20
Black plastic housing
L164/W64/H34mm
(L6.46/W2.52/H1.34in)

KKDM-05 1-10V

visDIM dimmable sub-controller



IP20
Black plastic housing
L164/W64/H34mm
(L6.46/W2.52/H1.34in)

KKSC-03A DMX (screw terminal)

visDIM dimmable sub-controller



IP20
Black plastic housing
L164/W64/H34mm
(L6.46/W2.52/H1.34in)

KKSC-03B DMX (RJ45)

visDIM dimmable sub-controller



IP20
Plastic housing
L170/W59/H29mm
(L6.69/W2.32/H1.14in)

KKDL-02 DALI

visDIM dimmable sub-controller
(4 x 8A max @ 12-36V)



MiMi Glow 008

Accessories



KKDC CONTROL (CONTINUED)



IP20
Plastic housing
L166/W53.4/H23mm
(L6.54/W2.10/H0.91in)

KKDL-03 DALI

visDIM dimmable sub-controller
(4 x 5A max @ 12-36V)

AVAILABLE PSU OPTIONS

Control Mode	PSU (Order Code)	Input Voltage AC	Output Voltage DC	Rated Output Current	Rated Power	Dim %	IP Rating
Switched	CEN-60-24	90-295V	24V	2.5A	60W	-	IP67
	HLG-60H-24	90-305V	24V	2.5A	60W	-	IP67
	HLG-100H-24	90-305V	24V	4.0A	100W	-	IP67
	HLG-150H-24	90-305V	24V	6.3A	150W	-	IP67
	HLG-240H-24	90-305V	24V	10A	240W	-	IP67
0-10V (1-10V)	PWM-40-24	90-305V	24V	1.67A	40W	100-0.15 (100-10)	IP67
	PWM-60-24	90-305V	24V	2.5A	60W	100-0.15 (100-10)	IP67
	PWM-90-24	90-305V	24V	3.67A	90W	100-0.15 (100-10)	IP67
	PWM-120-24	90-305V	24V	5.0A	120W	100-0.15 (100-10)	IP67
DALI	LIN100A1	120-277V	24V	1A per channel	100W	100-0.1	IP66/IP40
DMX RGB	LIN100A1	120-277V	24V	1.33A per channel	100W	100-0.1	IP66/IP40
DMX RGBW	LIN100A1	120-277A	24V	1A per channel	100W	100-0.1	IP66/IP40

Flicker Free Options - Combination of PSU+ sub-controller

Control Mode	PSU (Order Code)	Sub-controller (Order Code)	Input Voltage AC	Output Voltage DC	Rated Output Current	Rated Power	Dim %	IP Rating PSU/ Sub-controller
0-10V or 1-10V	CEN-60-24	KKDM-05	90-295V	24V	2.5A	60W	100-0.9	IP67/IP20
	HLG-60H-24	KKDM-05	90-295V	24V	2.5A	60W	100-0.9	IP67/IP20
	HLG-100H-24	KKDM-05	90-295V	24V	4.0A	100W	100-0.9	IP67/IP20
	HLG-150H-24	KKDM-05	90-295V	24V	6.3A	150W	100-0.9	IP67/IP20
	HLG-240H-24	KKDM-05	90-295V	24V	10.0A	240W	100-0.9	IP67/IP20
	CEN-60-24	KKDL-02/03	90-295V	24V	2.5A	60W	100-0.1	IP67/IP20
DALI	HLG-60H-24	KKDL-02/03	90-305V	24V	2.5A	60W	100-0.1	IP67/IP20
	HLG-100H-24	KKDL-02/03	90-305V	24V	4.0A	100W	100-0.1	IP67/IP20
	HLG-150H-24	KKDL-02/03	90-305V	24V	6.3A	150W	100-0.1	IP67/IP20
	HLG-240H-24	KKDL-02/03	90-305V	24V	10.0A	240W	100-0.1	IP67/IP20
DMX RGB	CEN-60-24	KKSC-03	90-295V	24V	2.5A	60W	100-0.9	IP67/IP20
	HLG-60H-24	KKSC-03	90-305V	24V	2.5A	60W	100-0.9	IP67/IP20
	HLG-100H-24	KKSC-03	90-305V	24V	4A	100W	100-0.9	IP67/IP20
	HLG-150H-24	KKSC-03	90-305V	24V	6.3A	150W	100-0.9	IP67/IP20
	HLG-240H-24	KKSC-03	90-305V	24V	10.0A	240W	100-0.9	IP67/IP20

¹ The items shown above cover the most frequently used specification but does not exhaust the possible options

² PSU and/or driver can be chosen from the table, or KKDC may recommend the best option upon receipt of the controls requirement and installation environment

³ Electrical shop drawing will include detailed information of PSU and relevant control drivers

⁴ Cut sheets are available on the controls section of www.kkdc.lighting or upon request