

Linear

TANA Nano 3 RS07

Fixture Guide

KKDC

Indoor | Surface | Output up to 455lm/m (139lm/ft)



Key applications

- ✓ Architectural detail
- ✓ Cabinet & furniture
- ✓ Direct lighting
- ✓ Display case
- ✓ Interior
- ✓ Retail display
- ✓ Shelving display

Key features

- ✓ Custom lengths
- ✓ Constant Voltage (CV)
- ✓ Diffusion: homogenous
- ✓ Direct view
- ✓ Extensive CCT range
- ✓ IP40 dry area
- ✓ Thin light line

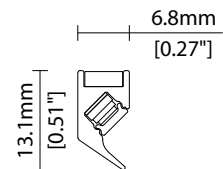

FIXING METHODS

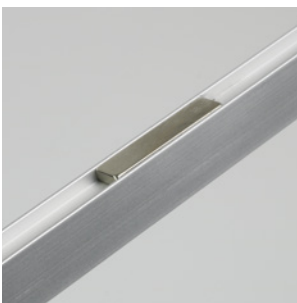

Magnet fixing

Linear

TANA Nano 3 RS07

Specification sheet



Dimensions	H13.1/W6.8/L76-2005mm (H0.52/W0.27/L2.99-78.94in)
PCB Cut-point	35.7mm increment/2000mm max (1.41in increment/78.74in max)
LED Pitch	6mm-168LED/m (0.24in - 51LED/ft)
Chip	s-line k-line
Cover/Optics	Diffused (90°)
CCT	s-line: 1900K/2100K/2300K/2500K/2700K/3000K/3500K/4000K/5000K k-line: 1900K/2100K/2300K/2500K/2700K/3000K/3500K/4000K/5000K
LED binning	s-line: 2-step MacAdam ellipse k-line: 3-step MacAdam ellipse
CRI	≥94
Lifetime	50,000 hours @ 25°C (50,000 hours @ 77°F)
Operating temp	T _a = -25 to 50°C (T _c max = 59.9°C) T _a = -13 to 122°F (T _c max = 140°F)
IP Rating	IP40
Finish	Silver anodised
Mounting	Surface mounting via magnet
Power feed	Hardwire tails or male/female connectors
Control	0-10V/1-10V/DMX/DALI



LED Grading Key

Exclusive Grade

s-line*
2-step CCT range

*KKDC tuned
CCT range

Base Grade

k-line
3-step commercial range
Energy Star CCTs

Power consumption	Supply voltage	Supply current
7W/m (2.13W/ft)	24V DC	0.29A/m (0.09A/ft)

Performance Data (3000K)

	R1	R2	R3	R4	R5	R6	R7	R8	R9	R10	R11	R12	R13	R14
k-line	95	98	98	94	95	97	92	83	64	95	96	81	96	99

Diffused		CRI	R9	Rf	Rg
s-line	455lm/m (139lm/ft) 65lm/w	95	65	-	-
k-line	427lm/m (130lm/ft) 61lm/w	94	64	-	-

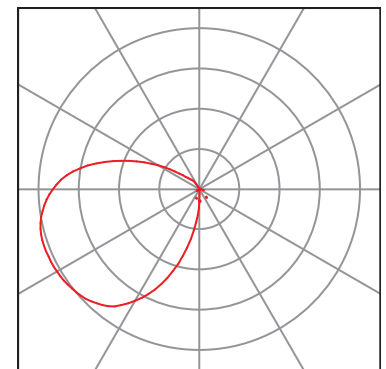
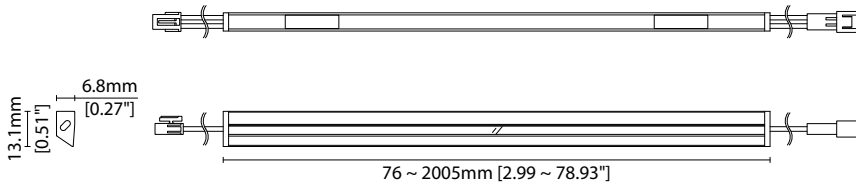

Diffused Cover
— C0 / C180 cd / 1000 lm C90 / C270

Data derived from independent UKAS / IESNA LM-79-08 accredited testing of production samples.

Linear

TANA Nano 3 RS07

Code Table

KKDC

FIXTURE

Model	Finish	Cover ¹	Grade ²	LED	Colour (CCT)	Length Availability ³	IP	Cable Length	Power Feed ⁴	Fixing ⁵	Input
TANA Nano 3	TA3 Silver Anodised	SA Diffused	C s k	RS07 RS07	1900K 19 2100K 21 2300K 23 2500K 25 2700K 27 3000K 30 3500K 35 4000K 40 5000K 50	m 76.0-2005mm 35.7mm increments i 2.99-78.94in 1.41in increments (Specify length code OR total run length)	IP40	40 50mm / 1.97" 300mm / 11.81" 0050 0300	Single no sheath tail S00X Double no sheath tail D00X Single no sheath IP20 connector S20X Double no sheath IP20 connector D20X	Magnet fixing MF	DC 24V g

¹ Refer to **Cover Options** on **Options** pages

² Refer to **LED Grading Key** on **Specification sheet** page

³ Refer to **Length Availability List** or enter total run length instead of length code

⁴ Refer to **Power Feed Options** on **Options** pages

⁵ Refer to **Fixing Options** on **Options** pages

Code Example:

TA3	-	SA	-	C	-	s	-	RS07	-	35	-	m	505	-	40	-	1000	-	S00X	-	MF	-	g
TANA Nano 3		Silver Anodised		Diffused		s		RS07		3500K		505mm		IP40		1000mm/39.37"		Single no sheath tail		Magnet fixing		DC 24V	

ACCESSORIES

Connection Accessories

KKCN-01	2 PIN male & female 50mm (1.97in) pair
KKCN-03	2 PIN male & female 300mm (11.81in) pair
KKCN-06	2 PIN 300mm (11.81in) extension lead

PSU/Driver

0-10V/1-10V/DALI/DMX

* Refer to **Driver/PSU Options** page for details or provide requirement and KKDC to offer the suitable option

* Refer to **Power feed** on **Accessories** pages

LED ENGINE VARIANTS (LED STRIP TYPE)

Colour	LED	Lumen/m	Lumen/ft	W/m	W/ft	Spec Doc	Length	Increment
Single CCT	RS07	455	139	7	2.13	TANA Nano 3 RS07	76.0-2005mm (2.99-78.94in)	35.7mm (1.41in)
	RS14	876	267	14	4.27	TANA Nano 3 RS14	76.0-2005mm (2.99-78.94in)	35.7mm (1.41in)

* Performance data: s/k-line, Diffused Cover 3000K

Linear

TANA Nano 3 RS07

Length Availability List



Length Code		Fixture Length ¹		LED Strip ²		End Cap Dimension ³		Wattage (W)	Output (lm)
Metric	Imperial(US)	Metric	Imperial(US)	Metric	Imperial(US)	Metric	Imperial(US)		3000K (Test Data)
m0076	i0003	76mm	2.99in	71mm	2.81in	4mm	0.16in	0.50	31
m0112	i0004	112mm	4.42in	107mm	4.22in	4mm	0.16in	0.75	46
m0148	i0006	148mm	5.82in	143mm	5.62in	4mm	0.16in	1.00	61
m0184	i0007	184mm	7.23in	179mm	7.03in	4mm	0.16in	1.25	76
m0219	i0009	219mm	8.63in	214mm	8.44in	4mm	0.16in	1.50	92
m0255	i0010	255mm	10.04in	250mm	9.84in	4mm	0.16in	1.75	107
m0291	i0011	291mm	11.45in	286mm	11.25in	4mm	0.16in	2.00	122
m0326	i0013	326mm	12.85in	321mm	12.65in	4mm	0.16in	2.25	137
m0362	i0014	362mm	14.26in	357mm	14.06in	4mm	0.16in	2.50	153
m0398	i0016	398mm	15.66in	393mm	15.47in	4mm	0.16in	2.75	168
m0434	i0017	434mm	17.07in	429mm	16.87in	4mm	0.16in	3.00	183
m0469	i0018	469mm	18.48in	464mm	18.28in	4mm	0.16in	3.25	198
m0505	i0020	505mm	19.88in	500mm	19.69in	4mm	0.16in	3.50	214
m0541	i0021	541mm	21.29in	536mm	21.09in	4mm	0.16in	3.75	229
m0576	i0023	576mm	22.69in	571mm	22.50in	4mm	0.16in	4.00	244
m0612	i0024	612mm	24.10in	607mm	23.90in	4mm	0.16in	4.25	259
m0648	i0026	648mm	25.51in	643mm	25.31in	4mm	0.16in	4.50	275
m0684	i0027	684mm	26.91in	679mm	26.72in	4mm	0.16in	4.75	290
m0719	i0028	719mm	28.32in	714mm	28.12in	4mm	0.16in	5.00	305
m0755	i0030	755mm	29.72in	750mm	29.53in	4mm	0.16in	5.25	320
m0791	i0031	791mm	31.13in	786mm	30.93in	4mm	0.16in	5.50	336
m0826	i0033	826mm	32.54in	821mm	32.34in	4mm	0.16in	5.75	351
m0862	i0034	862mm	33.94in	857mm	33.75in	4mm	0.16in	6.00	366
m0898	i0035	898mm	35.35in	893mm	35.15in	4mm	0.16in	6.25	381
m0934	i0037	934mm	36.75in	929mm	36.56in	4mm	0.16in	6.50	397
m0969	i0038	969mm	38.16in	964mm	37.96in	4mm	0.16in	6.75	412
m1005	i0040	1005mm	39.57in	1000mm	39.37in	4mm	0.16in	7.00	427
m1041	i0041	1041mm	40.97in	1036mm	40.78in	4mm	0.16in	7.25	442
m1076	i0042	1076mm	42.38in	1071mm	42.18in	4mm	0.16in	7.50	458
m1112	i0044	1112mm	43.79in	1107mm	43.59in	4mm	0.16in	7.75	473
m1148	i0045	1148mm	45.19in	1143mm	44.99in	4mm	0.16in	8.00	488
m1184	i0047	1184mm	46.60in	1179mm	46.40in	4mm	0.16in	8.25	503
m1219	i0048	1219mm	48.00in	1214mm	47.81in	4mm	0.16in	8.50	519
m1255	i0049	1255mm	49.41in	1250mm	49.21in	4mm	0.16in	8.75	534
m1291	i0051	1291mm	50.82in	1286mm	50.62in	4mm	0.16in	9.00	549
m1326	i0052	1326mm	52.22in	1321mm	52.02in	4mm	0.16in	9.25	564
m1362	i0054	1362mm	53.63in	1357mm	53.43in	4mm	0.16in	9.50	580
m1398	i0055	1398mm	55.03in	1393mm	54.84in	4mm	0.16in	9.75	595
m1434	i0056	1434mm	56.44in	1429mm	56.24in	4mm	0.16in	10.00	610
m1469	i0058	1469mm	57.85in	1464mm	57.65in	4mm	0.16in	10.25	625
m1505	i0059	1505mm	59.25in	1500mm	59.06in	4mm	0.16in	10.50	641
m1541	i0061	1541mm	60.66in	1536mm	60.46in	4mm	0.16in	10.75	656
m1576	i0062	1576mm	62.06in	1571mm	61.87in	4mm	0.16in	11.00	671

TANA Nano 3 RS07

Length Availability List



Length Code		Fixture Length ¹		LED Strip ²		End Cap Dimension ³		Wattage (W)	Output (lm)
Metric	Imperial(US)	Metric	Imperial(US)	Metric	Imperial(US)	Metric	Imperial(US)		3000K (Test Data)
m1612	i0063	1612mm	63.47in	1607mm	63.27in	4mm	0.16in	11.25	686
m1648	i0065	1648mm	64.88in	1643mm	64.68in	4mm	0.16in	11.50	702
m1684	i0066	1684mm	66.28in	1679mm	66.09in	4mm	0.16in	11.75	717
m1719	i0068	1719mm	67.69in	1714mm	67.49in	4mm	0.16in	12.00	732
m1755	i0069	1755mm	69.09in	1750mm	68.90in	4mm	0.16in	12.25	747
m1791	i0071	1791mm	70.50in	1786mm	70.30in	4mm	0.16in	12.50	763
m1826	i0072	1826mm	71.91in	1821mm	71.71in	4mm	0.16in	12.74	777
m1862	i0073	1862mm	73.31in	1857mm	73.12in	4mm	0.16in	12.99	792
m1898	i0075	1898mm	74.72in	1893mm	74.52in	4mm	0.16in	13.24	808
m1934	i0076	1934mm	76.12in	1929mm	75.93in	4mm	0.16in	13.49	823
m1969	i0078	1969mm	77.53in	1964mm	77.33in	4mm	0.16in	13.75	839
m2005	i0079	2005mm	78.94in	2000mm	78.74in	4mm	0.16in	14.00	854

¹ Actual total overall length of light fixture (LED strip + end caps + void/wire hole)

² Actual length of PCB strip

³ Actual length of 2x end caps

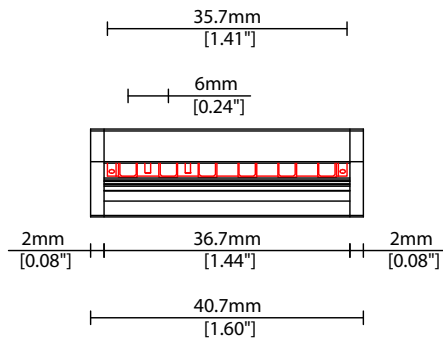

COVER OPTIONS

* Options are an integral part of the fixture ordering codes. Please refer to **Code Table** pages.

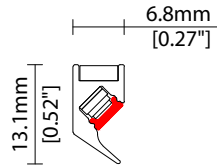

C Diffused Cover
Polycarbonate

FIXING OPTIONS

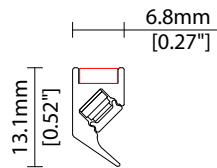

MF Magnet fixing

POWER FEED OPTIONS

0050 S00X 50mm (1.97") Single tail

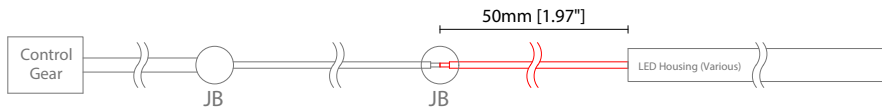

0050 D00X 50mm (1.97") Double tail

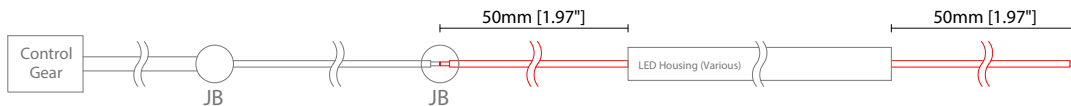

0050 S20X 50mm (1.97") Single IP20 connector

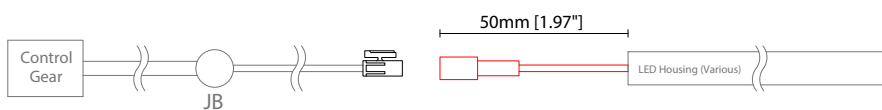

POWER FEED OPTIONS (CONTINUED)

0050 D20X 50mm (1.97") Double IP20 connector

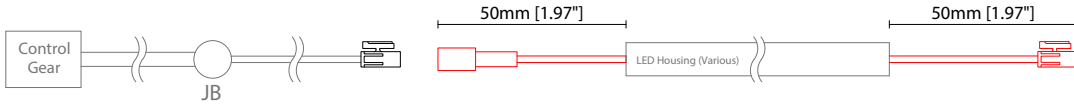

0300 S00X 300mm (11.81") Single tail

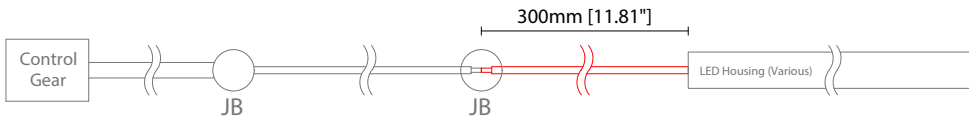

0300 D00X 300mm (11.81") Double tail

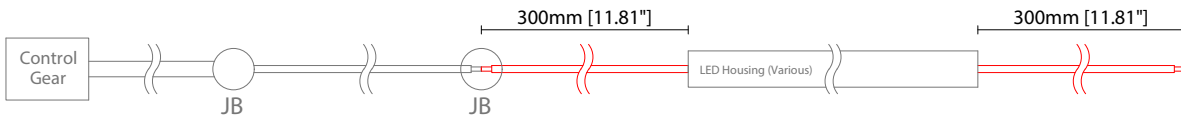

0300 S20X 300mm (11.81") Single IP20 connector

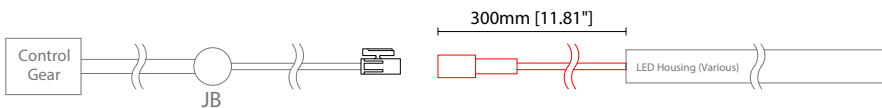

0300 D20X 300mm (11.81") Double IP20 connector

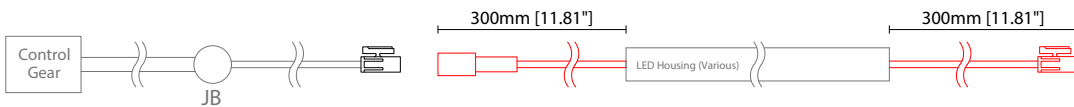

2 Pin Female Connector

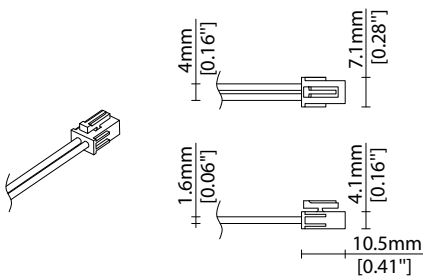

2 Pin Male Connector

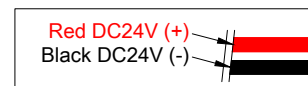
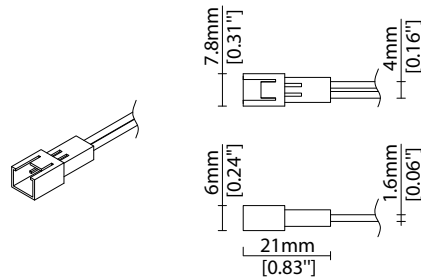

Key

Control Gear Power supply, sub-controllers & control systems
 JB Junction box / cable connection

POWER FEED

Note: Accessories are to be ordered separately with corresponding code shown below.

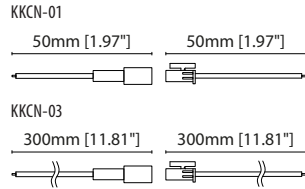
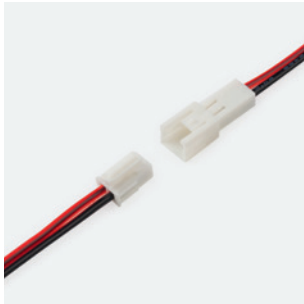

KKCN-01 50mm (1.97in) pair
KKCN-03 300mm (11.81in) pair
 2 PIN male + female connector set

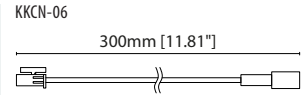

KKCN-06
 2 PIN 300mm (11.81in) extension lead

KKDC CONTROL



IP20
 Plastic housing
 L170/W59/H29mm
 (L6.69/W2.32/H1.14in)

KKDM-06 1-10V
 visDIM dimmable sub-controller
 (4 x 8A max @ 12-36V)



IP20
 Plastic housing
 L170/W53.4/H28mm
 (L6.69/W2.10/H1.10in)

KKSC-05 DMX
 visDIM dimmable sub-controller
 (4 x 5A max @ 12-36V)



IP20
 Plastic housing
 L170/W59/H29mm
 (L6.69/W2.32/H1.14in)

KKDL-02 DALI
 visDIM dimmable sub-controller
 (4 x 8A max @ 12-36V)



IP20
 Plastic housing
 L166/W53.4/H23mm
 (L6.54/W2.10/H0.91in)

KKDL-03 DALI
 visDIM dimmable sub-controller
 (4 x 5A max @ 12-36V)

AVAILABLE PSU OPTIONS

Control Mode	PSU (Order Code)	Input Voltage AC	Output Voltage DC	Rated Output Current	Rated Power	Dim %	IP Rating
Switched	CEN-60-24	90-295V	24V	2.5A	60W	-	IP67
	HLG-60H-24	90-305V	24V	2.5A	60W	-	IP67
	HLG-100H-24	90-305V	24V	4.0A	100W	-	IP67
	HLG-150H-24	90-305V	24V	6.3A	150W	-	IP67
	HLG-240H-24	90-305V	24V	10A	240W	-	IP67
0-10V (1-10V)	PWM-40-24	90-305V	24V	1.67A	40W	100-0.15 (100-10)	IP67
	PWM-60-24	90-305V	24V	2.5A	60W	100-0.15 (100-10)	IP67
	PWM-90-24	90-305V	24V	3.67A	90W	100-0.15 (100-10)	IP67
	PWM-120-24	90-305V	24V	5.0A	120W	100-0.15 (100-10)	IP67
DALI	LIN100A1	120-277V	24V	1A per channel	100W	100-0.1	IP66/IP40
DMX RGB	LIN100A1	120-277V	24V	1.33A per channel	100W	100-0.1	IP66/IP40
DMX RGBW	LIN100A1	120-277A	24V	1A per channel	100W	100-0.1	IP66/IP40

Flicker Free Options - Combination of PSU+ sub-controller

Control Mode	PSU (Order Code)	Sub-controller (Order Code)	Input Voltage AC	Output Voltage DC	Rated Output Current	Rated Power	Dim %	IP Rating PSU/ Sub-controller
0-10V or 1-10V	CEN-60-24	KKDM-06	90-295V	24V	2.5A	60W	100-0.9	IP67/IP20
	HLG-60H-24	KKDM-06	90-295V	24V	2.5A	60W	100-0.9	IP67/IP20
	HLG-100H-24	KKDM-06	90-295V	24V	4.0A	100W	100-0.9	IP67/IP20
	HLG-150H-24	KKDM-06	90-295V	24V	6.3A	150W	100-0.9	IP67/IP20
	HLG-240H-24	KKDM-06	90-295V	24V	10.0A	240W	100-0.9	IP67/IP20
DALI	CEN-60-24	KKDL-02/03	90-295V	24V	2.5A	60W	100-0.1	IP67/IP20
	HLG-60H-24	KKDL-02/03	90-305V	24V	2.5A	60W	100-0.1	IP67/IP20
	HLG-100H-24	KKDL-02/03	90-305V	24V	4.0A	100W	100-0.1	IP67/IP20
	HLG-150H-24	KKDL-02/03	90-305V	24V	6.3A	150W	100-0.1	IP67/IP20
	HLG-240H-24	KKDL-02/03	90-305V	24V	10.0A	240W	100-0.1	IP67/IP20
DMX RGB	CEN-60-24	KKSC-05	90-295V	24V	2.5A	60W	100-0.9	IP67/IP20
	HLG-60H-24	KKSC-05	90-305V	24V	2.5A	60W	100-0.9	IP67/IP20
	HLG-100H-24	KKSC-05	90-305V	24V	4A	100W	100-0.9	IP67/IP20
	HLG-150H-24	KKSC-05	90-305V	24V	6.3A	150W	100-0.9	IP67/IP20
	HLG-240H-24	KKSC-05	90-305V	24V	10.0A	240W	100-0.9	IP67/IP20

¹ The items shown above cover the most frequently used specification but does not exhaust the possible options

² PSU and/or driver can be chosen from the table, or KKDC may recommend the best option upon receipt of the controls requirement and installation environment

³ Electrical shop drawing will include detailed information of PSU and relevant control drivers

⁴ Cut sheets are available on the controls section of www.kkdc.lighting or upon request